



Design & Construction Standards Manual

2729 Prospect Park Drive
Rancho Cordova, California 95670
Phone (916) 362-1841 Fax (916) 362-9602

INTRODUCTION

Public parks are a reflection of a community's values and quality of life. Successfully designed parks build connections between residents of all social, economic and cultural backgrounds. They can help promote healthy lifestyles, encourage positive social interaction, and promote economic growth. In short, great parks make great communities.

Since 1959, the Cordova Recreation and Park District has been working to protect and maintain a park system that connects people and neighborhoods and draws visitors from throughout the region. This Design Standards & Construction Manual is intended for Designers, Developers, Contractors, and Consultants as they work on District Projects. The manual is not intended to limit creativity or innovation, but rather to ensure a certain level of quality is maintained throughout District sites.

During the design process, reference should also be made to the District's Master Plan, the County of Sacramento Standard Construction Specifications (most recent edition), and the City of Rancho Cordova Design and Construction Standards.

These standards do not replace other applicable codes or publications, such as the latest editions of the State of California Department of Transportation (Cal Trans) Standard Specifications, California Building Code or other regulatory agency requirements.

The protection of public health, safety and welfare shall be the overriding factor in the application of required standards and standards. In the case of conflict between these standards and the codes described above, the stricter of the two shall apply.

The District shall retain approval authority for all design, engineering and construction. Designers and builders will enter into an agreement with the Cordova Recreation and Park District before any planning, design or construction work commences.

TABLE OF CONTENTS

- 1. CONTACT INFORMATION**
- 2. PROCESS FOR DEVELOPER TURN-KEY PARK PROJECTS**
- 3. EXAMPLE PROJECT SCHEDULE**
- 4. CONSTRUCTION INSPECTION CHECKLIST**

SECTION 1 – DESIGN STANDARDS

- 1.01 Purpose of the Standards
 - 1.02 Design Adjacent to Streets
 - 1.03 Additional Design Standards
 - 1.04 Submittal Requirements
 - 1.05 Submittal of Landscape Plans
 - 1.06 Requirements upon Completion of Landscaping
 - 1.07 Level of Service Standards

SECTION 2 – GRADING

- 2.00 General Standards
- 2.01 Park Site Criteria
- 2.02 Definition of Contractor
- 2.03 Scope of Work
- 2.04 Quality Control
- 2.05 Submittals
- 2.06 Soil Testing
- 2.07 Materials
- 2.08 Execution

SECTION 3 – DRAINAGE

- 3.01 General Standards

SECTION 4 – HARDSCAPE

- 4.01 General Standards

SECTION 5 – FENCING

- 5.01 General Standards

SECTION 6 – LIGHTING

- 6.01 General Standards

SECTION 7 – PLAY AREAS

- 7.01 General Standards

SECTION 8 – SITE FURNISHINGS

- 8.01 General Standards
- SITE FURNISHING STANDARDS TABLE

SECTION 9 – RESTROOMS

- 9.01 General Standards
- RESTROOM FIXTURE STANDARDS TABLE

SECTION 10 – IRRIGATION SYSTEM

- 10.01 General Standards
- 10.02 Definition of Contractor
- 10.03 Scope of Work
- 10.04 Quality Control
- 10.05 Submittals

- 10.06 Pipes and Fittings
- 10.07 Reduced Pressure Backflow Preventer
- 10.08 Booster Pumps
- 10.09 Master Valve and Flow Sensor
- 10.10 Moisture Sensor
- 10.11 Remote Control Valves
- 10.12 Valve Boxes
- 10.13 Automatic Irrigation Controller
- 10.14 Automatic Irrigation Controller Wiring
- 10.15 Weather Stations
- 10.16 Gate Valves
- 10.17 Sprinkler Heads
- 10.18 Drip Irrigation
- 10.19 Quick Coupler Valves
- 10.20 Equipment Enclosures
- 10.21 Miscellaneous Equipment
- 10.22 Miscellaneous Installation Materials
- 10.23 Execution
- 10.24 General Installation
- 10.25 Site Conditions
- 10.26 Project Coordination
- 10.27 Protection of Improvements and Materials
- 10.28 Correction of Work
- 10.29 Trenching
- 10.30 Installation and Testing of Main Line and Lateral Lines
- 10.31 PVC Pipe and Fitting Installation and Connections
- 10.32 Copper Pipe and Fitting Installation and Connections
- 10.33 Brass and Galvanized Steel Pipe and Fitting Installation and Connections
- 10.34 Rubber Ring Seal Joint
- 10.35 Reduced Pressure Backflow Prevention Assembly
- 10.36 Reduced Pressure Vacuum Breaker Assembly
- 10.37 Booster Pump
- 10.38 Master Valve and Flow Sensor
- 10.39 Remote Control Valves and Valve Boxes
- 10.40 Automatic Irrigation Controller Wiring
- 10.41 Sleeves and Conduits
- 10.42 Automatic Irrigation Controller
- 10.43 Gate Valves
- 10.44 Sprinkler Heads
- 10.45 Equipment Enclosures
- 10.46 Adjustments and Corrections to the Irrigation System
- 10.47 Backfilling
- 10.48 Site Cleanup
- 10.49 Warranty

SECTION 11 – PLANT SELECTION AND PLACEMENT

- 11.01 General Planting Concepts
- 11.02 Turf
- 11.03 Planting near Utilities

- 11.04 Traffic Safety
- 11.05 Water Conservation

SECTION 12: PLANT LIST & USE GUIDE

- 12.00 Invasive Species
- 12.01 Approved Plant List
- 12.02 Planting Zones
- 12.03 Area Type
- 12.04 Water Use Area
- 12.05 Key Legend
- LARGE TREE LIST
- MEDIUM TREE LIST
- SMALL TREE LIST
- SHRUB / PERENNIAL LIST
- VINE LIST
- GROUNDCOVER LIST
- TURF LIST

DRAWING DETAIL INDEX

- | | |
|--|--|
| 1. Tree Planting | 28. Dugout Layout |
| 2. Trees on Slopes | 29. Turf Infield Irrigation Layout |
| 3. Shrub Planting | 30. Skinned Infield Irrigation Layout |
| 4. Shrubs on Slopes | 31. Trash Receptacle |
| 5. Groundcover Planting | 32. Barbeque – Surface Mounted |
| 6. Pipe Trench | 33. Barbeque – In Ground |
| 7. Sleeving at Pavement Crossing | 34. Volleyball Court Layout |
| 8. Thrust Block | 35. Horseshoe Court Layout |
| 9. Pop-up Rotor | 36. Wood Bollard w/Concrete Collar |
| 10. Pop-up Sprayhead | 37. Chainlink Fence |
| 11. Tree Bubbler | 38. Park Rules Sign |
| 12. 3” and Smaller Gate Valve | 39. Park Construction Sign 1 |
| 13. 3” and Larger Gate Valve | 40. Park Construction Sign 2 |
| 14. Remote Control Valve at Grade | 41. Area Light with Concrete Collar |
| 15. Domestic Water Main | 42. Playground Curb w/Resilient Surfacing |
| 16. Master Remote Control Valve | 43. Concrete Curbing/Edging |
| 17. Controller | 44. Concrete Curbing/Edging Cutout |
| 18. Quick Coupling Valve | 45. Concrete Curbing Along Asphalt |
| 19. Master Flow Valve with Sensor | 46. Concrete Curb and Gutter |
| 20. Concrete Curb at Play Areas | 47. Concrete Walk at Asphalt |
| 21. Concrete Mow Curb | 48. Concrete Paving |
| 22. Decomposed Granite Paving | 49. Control Joints |
| 23. Bike Trail Section | 50. Half Basketball Court |
| 24. Bike Trail Striping | |
| 25. Play Area Perforated Pipe Drain | |
| 26A. Drinking Fountain with Sump | |
| 26B. Drinking Fountain | |
| 27A. Play Area Ramp -- Plan | |
| 27B. Play Area Ramp -- Section | |

CONTACT INFORMATION

Cordova Recreation and Park District
 Park Planning and Design Development Department
 2729 Prospect Park Drive – Suite 230
 Rancho Cordova, CA 95670
 Telephone: (916) 362-1841
 Fax: (916) 362-9602
 www.crpdpd.com

Contact the Cordova Recreation & Park District for questions, reviews, approvals, inspections, landscape areas in the District Service Area, and for District maintained parks.

Division	Phone Number	email
CORDOVA RECREATION & PARK DISTRICT		
	Office: (916) 362-1841 FAX: (916) 362-9602	gail@crpd.com
District Administrator, Jim Rodems	Office: (916) 362-1841	jrodems@crpd.com
Park Planning Manager, Laura Taylor	Office: (916) 362-1841	ltaylor@crpd.com
Construction Inspector, John Biundo	Office: (916) 362-1841 (Call 48 prior to request an inspection)	jbiundo@crpd.com
Park Planner, Cristina James	Office: (916) 842-3312	cjames@crpd.com
Park Planner, Linda Roberson	Office: (916) 842-3317	lroberson@crpd.com
Park Services Manager, Gerald Dobbs	Office: (916) 362-1841	gdobbs@crpd.com
CITY OF RANCHO CORDOVA		
Planning Department	Office: (916) 851-8750	pjunker@cityofranhocordova.org
Public Works	Office: (916) 851-8710	cabhar@cityofranhocordova.org
COUNTY OF SACRAMENTO		
Municipal Services Agency (Public Works)	Office: (916) 874-5833	
Transportation Department	Office: (916) 874-6291	
Sewer – CSD-I	Office: (916) 876-6013	
Drainage	Office: (916) 874-6851	
REGIONAL WATER		
County of Sacramento	Office: (916) 874-6851	margettsd@sacounty.net
Cal American Water	Office: (916) 568-4251	info@amwater.com
Golden State Water	Office: (800) 999-4033	customerservice@gswater.com
SACRAMENTO METRO FIRE	Office: (916) 859-4300	communityservices@metrofire.ca.gov
Underground Service Alert (U.S.A.)	Office: (800) 227-2600	
SMUD	Office: (916) 732-5066	Jacobe.Caditz@smud.org

PROCESS FOR DEVELOPER TURN-KEY PARK PROJECTS

Step	The Developer shall...	The District shall...
1	Contact Park Planning & Development Manager to set up a meeting to review project and process. Include the proposed construction budget and schedule for design, construction document preparation, and construction. These items will be reviewed for compliance with the projects Park Development Agreement.	Meet with the Developer to review the project including: process, construction budget and schedule. District shall generate a project file for copies of the plans, specifications, permits, change orders, and all other project documentation both electronically and hard copy.
2	Generate a construction and/or reimbursement agreement between the District and the Developer(s).	Provide input and assistance toward the creation of the construction and/or reimbursement agreement. Submit to District Board for approval.
3	District to shall approve the Developer's Landscape Architect.	
4	Obtain a copy of the District Design Standards & Construction Manual for use by the Consultant, and Standard Construction Specifications from the County of Sacramento or Design and Construction Standards from the City of Rancho Cordova.	Provide a copy of the District Design & Construction Standards Manual to the Developer and Developer's Representative.
5	Submit to the District a Conceptual Master Plan and an estimate of probable costs based on the approved specific plan concept, for review and input.	Review and provide input on the Conceptual Master Plan.
6	Revise the submitted plan, based on District input, for completion of the Final Master Plan. Submit a colored and laminated 24" x 36" rendering, a high resolution .pdf copy, and a revised estimate of probable costs in Excel (Windows format) compatible version.	Upon receipt of the Final Master Plan, submit proposed plan to District Board for approval in concept.
7	Based on the Final Master Plan, developer will provide required permits and environmental clearances for the project.	
8	Submit Final Master Plan with approved environmental documentation and Final Cost Estimate to District for final approval by District Board of Directors.	Submit the Final Master Plan, Final Cost Estimate and environmental determination to the District Board for approval.
9	Provide construction documentation based on the Park Design Standards, applicable Standard Details and applicable Standard Construction Specifications. Submit at 50% and 95% completion to the District.	Review the construction documents at 50%, and 95% completion. Coordinate and forward all review comments on to the Developer's Landscape Architect for final incorporation into documents.
10	Revise and resubmit the construction documents to	Provide approval signatures for the final bid

DESIGN & CONSTRUCTION STANDARDS MANUAL: June 2015

	address District comments. Provide 100% completed construction documents to the District. Provide written responses to each District comment indicating where in the documents the response to the comment is located. Also include a Final Cost Estimate. Contractor shall submit to the District an electronic file of the approved construction document package in .dwg 2007 - 2010 compatible and .pdf.	documents.
11	Upon receipt of a fully executed cover sheet and set of approved plans, obtain bids for the construction of the project. Upon receipt of bids, provide the District with the results of the bid. Make recommendations for selection of the Contractor. Contractor must have an appropriate valid California A Contractor's License for the work and have experience building parks. Contractor shall provide portfolio of at least three projects that are similar in scope and size to the proposed project.	District shall provide a list of acceptable Contractors from which the Developer can choose the project Contractor. The Developer may submit alternative recommendations for District consideration. A representative of the District shall attend the bid opening and pre-bid meetings.
12	Obtain all applicable County permits, including, but not limited to, grading, drainage, encroachment, irrigation, splash pad areas, ADA, tree permits, and others as required by the County, City of Rancho Cordova, or other regulatory agencies. Submit copies of permits received to District.	District to retain copies in project file.
13	Upon District approval, proceed with the construction of the project. Notify the District's Construction Manager of the Pre-construction meeting and submit a preliminary construction schedule at that time.	District to participate in the Pre-construction meeting and ongoing inspections as required. District shall make inspections per the Construction Inspection Checklist.
14	Developer to provide a qualified professional liaison (i.e. Landscape Architect). The liaison shall be actively engaged throughout the entire progress of the project to monitor and communicate with the District during the progress of construction and any changes which may be need to be considered. This shall include the review of any submittals or other changes. The Developer shall ensure the District receives a copy of all submittals for review and approval. Developer will organize and attend weekly meetings on the construction site to review any changes or modifications to the project. The meeting shall include the liaison, Primary contractor, District Construction Manager at a minimum.	Participate in the on-site review, submittal reviews and inspection of construction progress. Attend routine construction meetings. The Developer shall provide testing results to the District.
15	Developer shall verify punch list completion. Obtain and submit certification by Landscape Architect and	Participate in the intermittent and Final inspections.

	District Construction Manager that park is built according to plans and specifications. Contractor shall meet or exceed all pre-arranged timelines established in the preconstruction meeting and as documented in the project scheduling .	
16	Submit the appropriate documentation for the deeding of the improved park property to the District for recordation. Provide as-built documents, all account information for relevant utilities, and maintenance plan.	Accept the project upon completion of all items: the formal dedication by the developer, upon satisfactory completion of the project including the maintenance period, and upon receipt of as-builts, warranties, equipment manuals, and manufacturer instructions, and maintenance plan. Transfer utility accounts.
17	The Developer shall complete the maintenance period (typically 90 days). After maintenance period is complete, the Developer shall provide all deeds and preliminary title report to the District. The Developer shall provide proof of all utility bills paid.	Upon completion of the maintenance period and receipt of all clean title documents, the District will bring the property before the Board for approval. Upon Board approval, all documents are brought to the County Recorder's Office by the District to file. On the day that the documents are recorded the property belongs to the District and the District's insurance activates. The District shall inform appropriate utility providers of the change in ownership. The public may occupy the site after the property is recorded.

EXAMPLE PROJECT SCHEDULE

Whether a park development project is to be designed by an in-house contracted Consultant or a Developer’s Consultant the District shall be provided with a project schedule. The schedule shall be critical path method format and produced in Excel, Project, or other scheduling software. Every project is different; therefore, schedules may vary from the template below. This is intended for use by Consultants as a guideline only.

TASK	TIMEFRAME
-------------	------------------

Community Meetings and Outreach

This phase varies widely in scope and schedule depending on the project and existing community. It is more applicable to community park design projects rather than turn-key park development.

Conceptual Design Phase

Site Survey	Varies (2 weeks typ.)
Geotechnical Report	Varies (2 weeks typ.)
Consultant Prepares Conceptual Plans	Varies
District Reviews Conceptual Plans	2 weeks min.
For Projects within the City of Rancho Cordova:	
Consultant Presents Project at Development Services Team (DST)	1 day

Design Development Phase

Consultant Prepares Design Development Drawings	Varies
District Reviews Design Development Drawings	2 weeks min.

Construction Document Phase

Consultant Prepares 50% Construction Documents	Varies
Consultant Submits Plans to District	1 day
District Reviews 50% Construction Documents	4 weeks min.
Consultant Prepares 90% Construction Documents	Varies
Consultant Submits Plans to District and Land Authority	1 day
Consultant Prepares 100% Construction Documents	Varies
Consultant Submits Plans to District and Land Authority	1 day
Consultant Prepares Bid Set	Varies
Project Bidding	6 weeks min.
Construction Administration	Varies

CONSTRUCTION INSPECTION CHECKLIST

Pre-construction Meeting

Verify approved plans
Verify submittals
Coordinate inspection process

Sleeving

Verify sleeving location depth, type and size,
Verify permanent marking system in place

Hardscape Site Amenities

Play equipment
Play equipment certification
Fencing, type, height, material
Flatwork, curbs, mow strips

Mainline

Mainline depth, type, marking, and size
Mainline connections, thrust blocks
Hydrostatic test (150 psi for 24 hours)
Verify manifold; meter, BF, MV, FS,

Backflow Preventer

Verify backflow Certification by others
Verify type, size, and location
Verify thrust blocks, hot rock cover, and pad

Booster Pump (as needed)

Location, enclosure
Installation, power connected, certification

Irrigation (Open Trench)

Verify lateral line depth, size, type
Lateral line pressure test
Verify head type, spacing, Swing joints
Wiring for size, depth, color (min 14 gage)

Irrigation (General)

Verify box supports, markings, valve I.D. tags
Wire connections, Reclaimed I.D.
Controller, type, stations, location, enclosure
installation, power, certification
Water Audit

Planting

Review & approve planting soil and agronomics soil test
Verify finish grade
Verify soil preparation and amendments
Verify plant species, size, quality, quantities, location
Planting layout, plant depth, tree staking
Final raking
Mulch installation
Turf installation
Hydro seed germination

Hardscape Site Amenities

Site furnishings
Signage installed

Final Acceptance

Turn over items, guarantees, warranties
Warranty Letter
Letter of Substantial Completion
Certificate of Occupancy

Maintenance

Compliance to begin maintenance
Turn over controller charts, as built
30 day walk through
60 day walk through
90 day final walk through

The District Inspector shall be notified 48 hours prior to backfilling of any utility or irrigation trenches.

The District Inspector shall be notified 48 hours prior to any concrete pour for inspection and approval of rebar placement.

SPECIAL TESTING AND INSPECTION IS REQUIRED FOR:

- Structural Concrete (high-strength)
- Structural Bolts (high-strength)
- Structural Steel Welding
- Any other building or development permit required STI

SECTION 1 - DESIGN STANDARDS

1.01 Purpose of the Standards

The purpose of these standards is to ensure that parks are designed to fit their context, to be unique and to function effectively in connecting community members to one another and their environment. These standards are to be used by consultants, both in-house as well as those hired by others, during design development. These specific standards also contain conceptual guidance for improved park design. The proposed park improvements shall include the program elements outlined in the District Board approved Master Plan. As this section only provides general design criteria, the Landscape Architect shall refer to other sections to determine acceptable products and materials and the construction standards by which they shall be installed, as well as the maintenance requirements.

1.02 Design Adjacent to Streets

These standards serve to strengthen aspects of the physical layout, function, and overall character of the District's streetscapes as they are experienced by residents and visitors who use the park system. The standards encourage the expression of functional and land use distinctions through changes in the visual character of street components. For example, formal street tree planting should be used in residential areas whereas planting adjacent open spaces and riparian corridors should enhance and respect these natural features.

The following design concepts are intended to promote these goals:

- A. Foster a recognizable character for communities:
- B. Emphasize entries and exits, including those that are gated.
- C. Respond to the natural and cultural structure of the community.
- D. Transitions between the park and road shall be well-designed and have a welcoming expression.
- E. Plant native oaks where appropriate.
- F. Use street trees to create a sense of spatial enclosure at the street edge.
- G. Encourage visibility of public areas.
- H. Use natural-looking elements, such as stone or split face CMU wall and on hillside retaining walls, etc.
- I. Utilize a plant palette that conserves water per the approved plant list in Section 12 or as approved by District Park Planning & Development Manager.

1.03 Additional Design Standards

All designs for District facilities shall comply with any and all applicable Local, State and Federal laws and building codes.

1.04 Submittal Requirements

All plans shall be prepared by the appropriate licensed professional.

Construction Documents:

- A. Submit two (2) sets of paper plans, one (1) set of digital plans (.pdfs) and any additional sets requested by the District shall be submitted.
- B. Plans shall include the signature and license or certification number, if applicable, of the design professional that prepared the plans.
- C. Plans shall be submitted on uniform size sheets, 24"x 36" overall dimension.
- D. The scales for various portions of the drawings and the north point where applicable shall be shown on all sheets.
- E. All printing or lettering on the plans shall be of 1/8" minimum height and of such shape and weight as to be readily legible on prints and microfilm reproductions.

1.05 Submittal of Park Plans

If District Planning Department approval is required for a project (i.e., design review, use permit, or planned development), a construction drawing package submittal is required.

For Development Reviews of turnkey parks, landscape corridors, or other Developer projects related to District lands, an application and initial drawing review fee is required from the developer. For internal projects where the District is the property owner and has retained a Consultant, no application is required for drawing review.

1.06 Level of Service Standards

Consultants shall refer to the approved Master Plan which describes District Level of Service Standards.

SECTION 2 – GRADING

2.00 General Standards

- A. Consider functional effectiveness, ease and cost of long term maintenance, aesthetics, and traffic safety when grading.
- B. Accommodate proposed and existing utility vaults. In cases where walls around vaults are unavoidable, walls shall be masonry or concrete.
- C. Meet existing elevations at property lines while providing drainage per the California Model Water Efficient Landscape Ordinance.
- D. Minimum slope of turf areas is 2%. Maximum slope is 6:1 (17%), unless otherwise approved by District.
- E. Maximum slope of shrub areas shall be 3:1 (33%).
- F. Crown playing fields such as baseball and softball at 1.5%. Informal playing fields shall be sloped at 2%.
- G. Soccer fields shall be graded with a level crown down the centerline and a slope to the touch line of 1.5%.
- H. Provide adequate level areas for spectator seating on at least two sides of playing field and/or behind backstops.
- I. All native grass and planting areas shall provide positive storm water drainage per the California Model Water Efficient Landscape Ordinance.
- J. Drainage on all asphalt and concrete surfaces shall be directed to catch basins and the storm drain system, bioswales or detention facilities.
- K. Cross slope on all walkways shall not exceed 2%.
- L. Minimum slope on concrete surfaces shall be .5% (i.e. under pavilions).
- M. Minimum slope on asphalt surfaces shall be 1.5%.
- N. Longitudinal grades on pathways shall be less than 5% maximum.
- O. Ensure compliance with the most current update of the Americans with Disabilities Act (ADA) and the California Building Code (most current edition).
- P. Minimize the need for handrails whenever possible.

- Q. Hard court surfaces shall be graded at minimum of 1% perpendicular to the long axis.
- R. Comply with County of Sacramento and City of Rancho Cordova Oak & Heritage Tree Ordinance – as applicable.
- S. Trails and bikeways inside park properties shall be constructed per District standards (see CRPD Design Details).

2.01 Park Site Criteria

A. For all Developer owned future park land, the Developer shall deliver to the District a site suitable for park development. The park site must meet **all** the following criteria to be deemed “suitable”:

- All utilities must be stubbed out at boundary of property (electrical, water, storm drainage, sewer)
- Improvements of street frontage (curb, gutter, sidewalk, and landscaping within ROW) must be provided
- Site shall not have been used as a staging area, to stock pile material or as a disposal site during construction unless approved in writing by the District.
- Site shall be generally level and free of erosion or drainage issues
- The Developer shall comply with the following conditions:
 1. Geotechnical Engineering Report prepared for site development of parks shall include borings/test pits on park sites and discussion/recommendations relative to park development.
 - a. A minimum of two (2) borings/test pits shall be performed for each park. The final number of borings/test pits will depend on the size of the park, but there shall be at least one boring/test pit for every two acres of park, or portion thereof.
 - b. Borings/test pits shall extend to a minimum depth of five (5') feet for sites with five (5') or less of topographic relief and up to ten (10') for sites with greater than five (5') of topographic relief.
 - c. Soil samples shall be collected and tested for gradation (grain-size), and expansive characteristics. Results of the laboratory testing shall be included in the Geotechnical Engineering Report.
 2. At the completion of rough grading each park site shall contain a volume of landscape soil sufficient to provide at least twelve (12") inches of soil over the entire park acreage (approximately 1600 cubic yards per acre). Soil may consist of natural undisturbed native soils, stockpiled soil from other areas of the development, or approved import.
 3. Suitable landscape soils are defined as meeting the following physical characteristics:
 - a. Soils shall be relatively uniform in texture (uniformly graded) and meet the following gradation requirements:
 - maximum rock size of three (3") inches;
 - at least ninety percent (90%) shall pass a ¾" sieve;
 - at least eighty percent (80%) shall pass a No. 4 sieve; and
 - at least forty percent (40%) shall pass a No. 200 sieve.

- b. The Expansion Index (EI) of the soil shall be fifty (50) or less
 - c. Native or import soils shall not contain any significant rubble and debris, and be free of any known contaminants.
- B. The fully developed park site soil shall meet the following minimum standards within the first 12" or as modified by soil test and fertility recommendations determined by testing:

CHEMISTRY

Reaction (pH) saturated paste	6.0-7.6
Salinity (ECe dS/m) saturation extract	<3.0
Sodium adsorption ratio (SAR)	<6.0
Boron in saturation extract, ppm	<1.0

TEXTURE

Particle Size Passing	USDA Sieve Size (mm)	Objective – Percent
Gravel	No. 3/4" Sieve	>100%
Coarse sands	No. 4	>80%
Silt plus clay	No. 200	<40%

***Use Hydrometer method**

Verification for conformance with topsoil parameters shall be provided via a fertility, agricultural suitability and partial size soil test.

2.02 Definition of Contractor

The term "contractor" is used in its broadest sense within this section. The Contractor may be a Developer/Contractor installing public improvements to be turned over to the District for maintenance, the District Park Services Department, or Construction Contractors hired on contract by the District.

2.03 Scope of Work

- A. The Contractor shall perform all soil preparation work including, but not limited to:
 - 1. Topsoil placement.
 - 2. Organic amendment.
 - 3. Fertilizer placement.
 - 4. Finish grading.

- B. The work shall include the provision of all labor, materials, equipment and apparatus not specifically mentioned herein or noted on the Reviewed Plans, but which are incidental and necessary to complete the work specified.

2.04 Quality Control

A. CODES AND STANDARDS:

All construction shall comply with any applicable standards and current and applicable Local, State and Federal ordinances and Building Codes.

B. SAFETY:

1. All work shall be performed in a safe manner and shall meet or exceed the safety standards established under the Federal Occupational Safety and Health Act and its most current amendments.
2. Barricades, guards, warning signs, and lights shall be erected and maintained as required by OSHA regulations, the Property Owner, or by the District for the protection of the public and workers.
3. Where work infringes upon the public right-of-way, traffic control plans shall be submitted and encroachment permits obtained from the local land use authority.

C. PERSONNEL:

1. The Contractor shall possess all proper and current licenses, certificates, permits and/or registrations required to perform the scope of services.
2. The Contractor shall employ at least one qualified supervisor familiar with the products and requirements of this section. The supervisor shall be present at the project at all times. The supervisor shall have full authority to act on behalf of the Contractor.
3. The Contractor shall employ workers familiar with the products and requirements of this section.

D. SITE PROTECTION:

1. The Contractor shall incur all expenses to repair or replace any damage to existing improvements, such as buildings, equipment, irrigation systems, piping, sewers, sidewalks, or landscaping caused during activities related to the scope of work in this section. Repairs and replacements must be done in a manner and to a quality level satisfactory to the Owner and District within a reasonable timeframe as determined by the District.

2. The Contractor shall exercise extreme care when excavating and working near existing utilities. The Contractor is responsible for correcting any damage to existing utilities for which the Contractor's operation is either the direct or indirect cause. The Contractor is required to call **Underground Service Alert (USA) at (800) 227-2600** for marking of underground utilities prior to excavating.

2.05 Submittals

The Contractor shall provide the soil analysis report and written certificates stating quantity, type, composition, weight, and origin for all amendments. Chemicals shall be approved by the District before the material is used on the site.

2.06 Soil Testing (see Section 2.01 for more information)

- A. The Contractor shall provide two (2) one-quart samples to a District-recognized testing laboratory, for testing for conformance to this specification.
 1. Sample one shall be from the proposed import topsoil
 2. Sample two shall be from the proposed planting area.
- B. For areas larger than 100,000 square feet, one additional sample shall be analyzed for each additional 50,000 square feet of landscaped area.
- C. If the total length of the landscaped area, measured longitudinally, exceeds 2,500 linear feet (i.e. for median island strips or backing lot treatments), one representative composite sample shall be analyzed for each 2,500 linear feet segment.
- D. For multiple, discontinuous landscaped areas within one project, one representative composite shall be analyzed for each distinct area, if the areas are separated by more than 2,500 feet.
- E. If different soil textures or colors are discovered while sampling, a representative sample from each distinct soil type shall be analyzed.
- F. One representative soil for every 3,000 cubic yards of import soil shall be analyzed.
- G. Each composite sample shall be a mixture of 10 or more sub-samples taken from the rooting depths of the proposed plantings. Typical rooting depths are as follows:
 1. Turf and herbaceous groundcovers: 0 to 6 inches
 2. Shrubs and Trees: 0 to 12 inches
- H. Each soil sample shall be analyzed to determine its soil chemistry for all of the following:

1. Alkalinity or acidity (pH)
 2. Fertility
 3. Landscape compatibility
 4. Soil classification and particle size
 5. Percolation or infiltration rate
 6. Boron content
 7. Salinity; including Electrical Conductivity (ECE) and Sodium Absorption Ratio (SAR)
 8. Any calcareous or chlorotic conditions
 9. Any other condition deemed important by the horticulturalist, or requested by the District.
- I. No material shall be delivered to the site until the District approves the material.
- J. All testing costs shall be paid by the Contractor, including initial samples and any additional samples required due to non-compliance by the contractor.
- K. The results of the horticultural analysis shall be presented in a report that shall include recommendations for soil amendments, fertilization, drainage, Ph, and other necessary measures to assure a successful landscape design and plant life sustainability. The depth of the water table, if known, shall also be included in the report.
- L. The Contractor shall provide a one-quart sample of each proposed amendment to the testing laboratory for testing for conformance to this specification and recommendations for incorporation. No material shall be delivered to the site until the District approves the material. Amendment testing costs shall be paid by the Contractor. Acceptable labs include:
- Sunland Analytical --- (916) 852-8557
- Soil & Plant Laboratory, Inc. --- (408) 727-0330
- M. For landscaped and hard-surfacing areas, the Contractor shall submit the pre-emergent herbicide information for approval by the District before any application.

2.07 Materials

- A. Imported Topsoil for Contained Planter Areas:
1. A minimum 12-inch layer of clean topsoil shall be provided in all planting areas.
 2. The planting soil shall meet the recommendations of the horticultural analysis report.

3. The planting soil shall be free of any refuse, heavy or stiff clay, hard dirt clods, stones larger than 3/4 inch, roots larger than 3/4 inch in diameter, litter, and other deleterious materials.
4. The planting soil shall be free of noxious weeds, Bermuda grass, nut grass, or other invasive wild-land pest plant material, toxic amounts of boron, acid or alkaline chemicals, and shall be capable of sustaining healthy plant life.
5. Site strippings may be stockpiled and then used as planting soil, provided the material conforms all applicable criteria.
6. Topsoil shall be a homogeneous mineral soil classified as sandy loam, or fine sand and meet the following requirements:
 - a. Particle size data shall be based upon standard USDA methodology.
 - b. Soil shall be 5% Organic Matter
 - c. Provisions shall be made to add required materials to the soil, as recommended by the testing laboratory in order to support normal plant growth.
 - d. The soil shall be free of organic herbicides or other growth restricting chemicals.
 - e. Contamination may be tested by greenhouse trials using rye grass and radish as test crops using the existing import soil as substrate. These trials require four to five weeks for completion.
 - f. Submit samples/test results for approval prior to install.

B. Fertilizer:

1. All fertilizers shall be commercially processed and shall conform to the requirements of the agricultural laws and regulations applicable in the State of California.
2. Unless otherwise specified, the fertilizer shall be a long-term, slow-release, water insoluble, nitrogen-based product.
3. The fertilizer shall be pellet, granular, or tablet form and shall have the chemical composition clearly marked on the packaging material for inspection by the District. The packaging must list the relative amounts of the three major macro-nutrients – Nitrogen (N), phosphorous (P), and potassium (K) – as percentages of the total weight. If other macro-nutrients (e.g. magnesium, sulfur, calcium) or micro-nutrients (e.g. chlorine, iron, boron, manganese) are included in a fertilizer, these must also be listed on the packaging. The fertilizer packaging must also indicate whether the product is “fast-release” or “slow-release”.
4. Fertilizer shall be determined from soil analysis results, which shall be provided to the District.

2.08 Execution

A. Clearing and Grading:

1. The Contractor shall complete the rough grading as necessary to round the top and toe of all slopes, providing naturalized contouring to integrate newly graded areas with the natural topography. Finish grading shall be completed in accordance with the information shown on the District Approved Landscape Plans.
2. In all areas to be planted, remove and properly dispose all rocks and paving materials over 3/4 inch in any dimension and all weeds, debris, and other deleterious or noxious material as described above.

B. Topsoil Preparation:

1. If in-place soils are to be amended to create the topsoil layer, the in-place soils within the areas to be planted shall be cross-ripped and scarified to a minimum depth of 12 inches (six inches in turf areas) and compacted to 85% before import is brought in and prior to the addition of amendments and fertilizers.

If import soil is used for topsoil, the underlying sub-soil shall be cross-ripped and scarified to a minimum depth of 12 inches before topsoil is placed. The import soil shall then be incorporated and mixed with the sub-soil so that there is a gradual change from sub-soil to topsoil, rather than a sharp distinction.

3. Following the ripping and scarifying operation, all areas to be planted shall be tilled to break down clods, to expose deleterious material to be removed, and to incorporate soil amendments and/or commercial fertilizer. Amendments and fertilizers shall be evenly distributed and incorporated throughout the topsoil layer.
4. The tilling operation shall be performed until the ripped and scarified soil is in a loose condition and the amendments and fertilizers are thoroughly mixed.
5. The outer limits of the areas to be cultivated shall extend a minimum of 12 inches beyond the outer row of plants requiring cultivation, unless otherwise stated on the plans.
6. The use of rubber-tired equipment will be permitted for cultivating operations provided that the equipment used completely eradicates any compaction caused by the tires. Rubber-tired equipment will not be allowed on cultivated areas after cultivation.

7. Fine grading work shall not be performed when the moisture content of the soil is such that excessive compaction will occur, or when the soil is so dry that clods will not break readily or dust will form in the air. Apply water as required to prevent the formation of an airborne dust nuisance and to provide ideal soil moisture content for tilling.

C. Pre-emergent Herbicide:

1. Pre-emergent herbicide shall be applied in accordance with the manufacturer's recommendations for all tree ring, ground cover, and shrub bed areas. The Contractor shall adhere to all agricultural laws and regulations applicable in the State of California and the manufacturer's safety recommendations when using agricultural chemicals.
2. The pre-emergent herbicide shall be applied before mulch is placed.
3. The Contractor shall use care in applying pre-emergent herbicide to avoid damaging any existing trees or other landscape features scheduled to remain. Herbicide shall not be applied during windy conditions to avoid spray drift.
4. All employees using chemicals shall be trained in the proper use of these chemicals and shall be licensed or certified as required by state and local agencies.

Finish Grading:

1. The Contractor shall finish grade all irrigated planting areas unless otherwise noted, and shall remove all rocks and clods over 3/4 inch.
2. All areas shall be smooth and uniformly graded.
3. The Contractor shall repair all erosion damage during the construction period.
4. Unless otherwise noted on the Reviewed Landscape Plans, all soil finish grades shall be 1 inch below finish grade of walks, pavements, and curbs.

SECTION 3 - DRAINAGE

3.01 General Standards

- A. Landscape designs shall meet requirements of all applicable Sacramento County Codes and the Sacramento County Stormwater Quality Design Manual and reflect Best Management Practices for control of stormwater.
- B. Invert elevations on all drainage facilities and pipes shall be located on plans.
- C. All drainage pipes shall be PVC pipe, SDR-35, with a minimum diameter size of 8-inch diameter and a minimum slope of 0.5%.
- D. Do not locate drains within, or immediately adjacent to, a play field. Maintain a minimum separation of 20 feet from play fields.
- E. Sheet drain basketball courts to a pre-sloped trench drain system.
- F. Catch basins shall be a minimum of eighteen inches (18"). Catch Basins shall be concrete with bolt-down and bicycle proof grates.
- G. Drainage for swales in landscape or turf areas shall be a minimum slope of 2%.
- H. Do not sheet drain from planted or landscaped areas across hardscape.
- I. Avoid sheet draining across long distances.
- J. For storm drain and other utility stubs to future phases of work, cap and locate with a marker at grade.
- K. Do not place drains within any existing native Oak or Heritage Tree canopy.
- L. Storm Water Pollution Prevention Plan (SWPPP) is required on all projects. Storm water treatment shall comply with all SWPPP regulations and requirements.
- M. When and where possible designers should look for ways to reduce hardscape and increase site permeability to reduce stormwater runoff (i.e. through the use of detention basins, permeable paving, and swales).

SECTION 4 - HARDSCAPE

4.01 General Standards

- A. Non-vehicular-rated concrete walks shall be a four (4) inch depth of concrete with 2.9x2.9x6 welded wire mesh reinforcing with 'dobies/chairs' on four (4) inch depth of compacted Class II aggregate base material (per District standard details) or per the recommendations contained in a site geotechnical study, whichever is greater. 12" dowels shall be located in new concrete sections that are constructed adjacent to existing concrete sections. Felt material shall be placed in sidewalk expansion joints and capped with a Sealtight Expansion Joint Snap-Cap. Joints shall then be sealed with Sikaflex sealant or approved equal.
- B. Vehicular-rated concrete walks shall be designed and constructed per the recommendations contained in a site geotechnical study.
- C. In general, sport courts shall be a four (4) inch depth of concrete with 2.9x2.9x6 welded wire mesh reinforcing with 'dobies/chairs' on four (4) inch depth of compacted Class II aggregate base material (per District standard details) or per the recommendations contained in a site geotechnical study, whichever is greater. Acrylic sports court surfacing with the appropriate playing lines shall be applied as the top course. Acrylic sports court surfacing shall be asphalt or post-tension concrete where cracks or expansion joints could affect the play of the ball.
- D. The use of decomposed granite shall be limited to areas (such as around utilities) where growing and maintaining vegetation is difficult. Decomposed granite may be used as material for associated sports, such as bocce ball, but not as a primary walkway material.
- E. Acceptable manufacturers include: Plexipave, Surface America, or equal.
- F. All manufacturer's recommendations should be followed.

SECTION 5 - FENCING

5.01 General Standards

Chainlink

- A. Where fencing is related to a specific facility (tennis courts, backstops, etc.) install black, blue or green (per District direction) vinyl coated chain link fabric, with posts and fittings primed and painted to match.

- B. Minimum fabric wire size shall be (9)-nine gauge.

Ornamental Fencing

- A. Ornamental steel fencing shall be 14 gauge steel minimum and manufactured by Ameristar Fence Systems or approved equal.

Post and Cable Fencing

- A. At certain park sites where a physical barrier is needed, but a visual barrier is not desired, the use of post and cable fencing may be preferred to other fencing types (i.e. between park site and adjacent City-owned open space, preserve area, or bike trail).

SECTION 6 - LIGHTING

6.01 General Standards

- A. All lighting design shall be compliant with 2013 Energy Efficiency standards set by the California Energy Commission.
- B. Park security lighting shall be provided in all park settings.
- C. Activity nodes such as playgrounds and picnic areas shall be lit at an average of 1/4 foot-candle.
- D. City and County requirements for parking lot lighting shall prevail.
- E. Penetration of unwanted light into adjacent neighborhoods shall be mitigated as much as possible.
- F. Parking lot lighting shall comply with all applicable codes including the California Energy Commission Standards.
- G. When possible, lighting standards shall comply with the Model Lighting Ordinance (MLO).

SECTION 7 - PLAY AREAS

7.01 General Standards

- A. All play areas shall comply with applicable codes including Americans with Disabilities Act (ADA), Consumer Product Safety Commission Guidelines (CPSC) and National Playground Safety Institute Guidelines (NPSI).
- B. When space allows, more than one play area should exist in a park. Equipment should promote muscle development, motor coordination, social interaction, fantasy, creativity, and dramatic play.
- C. A toddler-scale play area should be provided for younger children (under 5 years) in all parks. In larger parks, larger play apparatus may be provided in a separate area for older children, adjacent to school uses if applicable.
- D. All play areas shall have adjacent seating for adult supervision.
- E. Play areas shall be made up of high quality and innovative play structures and/or play/exploration elements.
- F. Poured-in-place rubberized surfacing is the preferred playground surfacing material for play areas (as budget allows).
- G. Colors of the play components shall be approved by the District.
- H. Play equipment selected shall be reviewed and approved by the District for adequacy.
- I. Site the play area for safe play and easy viewing from the street or parking lot. Play areas fifty feet (50') or closer to roads shall have three to four foot (3'-4') tall protective decorative fencing.
- J. Chain link fencing shall not be used in any play area.
- K. Inclusion of wood play equipment should be considered on a case-by-case basis by the District.
- L. "Age Appropriate" signs should be posted within the play areas. The sign language should describe the intended age range of the user the requirement for adult supervision.
- M. Provide for an accessible path of travel to every major play component (the transfer deck of an active play structure and one belt swing). The path of travel must be constructed of non-friable materials. This path shall be indicated on the plan.

- N. Fall zones shall be in compliance with accepted standards and requirements.
- O. The same surfacing material shall be used throughout the swing area (including fall zone).
- P. Provide a perforated pipe drainage system within engineered wood fiber play areas per District standard details. Provide drainage system under poured-in-place resilient surfacing play areas as recommended by manufacturer. Locate all drainage system catch basins, drain inlets, or clean outs **OUTSIDE** of play areas with adjacent landscape or turf areas.
- Q. Trees shall be planted immediately adjacent to play lots to provide 50% shade over the play area within 5 years.
- R. Sports fields/courts shall be oriented with a North-South axis, unless otherwise approved by the District.
- S. The District encourages the use of deviations such as climbing rocks, webbing, etc and the use of innovative and interactive play equipment.
- T. Play area elements include but are not limited to:
 - 1. Required Elements (in order of priority and as space permits)
 - a. Play Equipment for children under 5 years
 - b. Seating Area for adult supervision
 - c. Apparatus play area for 5-12 year olds
 - d. Planting to provide shade for seating areas
 - e. Trash Receptacles (per District standard)
 - f. Drinking Fountain (per District standard)
 - 2. Optional Elements:
 - a. Sand Play Area
 - b. Tricycle Course

U. Spray/Splash Pad Areas: Splash pad areas shall comply with the California Conference of Directors of Environmental Health Recreational Health Technical Advisory Committee Standards for Construction & Operation of Spray Grounds.

- 1. Spray ground plans must be reviewed and approved by the County of Sacramento Environmental Management Department.

V. Acceptable playground manufacturers:

- Landscape Structures
- Berlinger

- Kompan
- Little Tykes
- Miracle
- Playworld
- (Or Approved Equal)

SECTION 8 - SITE FURNISHINGS

8.01 General Standards

- A. Site furnishings shall be sturdy, simple in construction, and made of vandal resistant materials.
- B. Site furnishings shall not be made of wood, unless otherwise approved by the District.
- C. Site furnishings and amenities shall comply with the Americans with Disabilities Act (ADA).
- D. Elements such as play areas and sports fields shall have associated seating and/or picnic areas.
- E. Site furnishing and finishes colors shall be approved by the District.
- F. Trash receptacles shall be placed near all seating areas, play lots, picnic areas, sports fields, tennis courts, parking lots and all other high use areas as directed by District.
- G. Picnic tables shall be shaded with trees or a structure, and located in groups as well as individually. There shall be one picnic table per acre minimum.
- H. A 3' minimum clearance shall be provided between picnic tables and other obstructions per ADA requirements.
- I. Use surface mount site furnishings except with prior written approval.
- J. Amenities shall be designed and installed in a manner that prevents inappropriate skateboarding. Provide District approved skate stoppers or similar devices.
- K. All benches and tables shall be placed on a concrete pad. Provide a three foot (3') minimum concrete clearance all back, left and right sides of all site furnishings.
- L. The use of recycled content equipment, surfacing, and site furnishings is encouraged.
- M. Site furnishings quantities shall be consistent with the District's Basic Park Improvements for Neighborhood and Community Parks

Site Furnishing Standards
8.02 Approved Site Furnishings

Description	Manufacturer & Model Number	Comments
Sport Backstop with Hood (Permanent Install)	Patterson Williams Athletic Manufacturing Company: 1240-03 with 3 planks, black PC frame and vinyl coated mesh	Or approved equal
Sport Backstop (Portable)	Patterson Williams Athletic Manufacturing Company: 1240-12 with Vinyl Coated Mesh	Or approved equal
Ball Field Mix	50/50 Red lava and clay loam	Or approved equal
Basketball Goals		4" Galvanized Steel Posts or approved equal
Softball Bases and Pitching Rubber	Hollywood Home Plate (10350 Step down pitching rubber, Saf-T-Slider Base) Double First. Base (10390) Anchor Ground Spikes (10053, 10050) (10225)	One (1) per Field Two (2) per Field One (1) set per Field Nine (9) total per Field
Barbeque Grills	Little Tykes (200-X, 210-X or 220-X) Outdoor Creations Model# 300A Family BBQ Unit	Finishes to be approved by District
Bike Racks	LA Steelcraft (WB-700) Dumor (125, 130) FairWeather (BR-1.5) Belson Orion Bike Rack (Round Tubing)	Loop style, powder coated
Drinking Fountains	Most Dependable Fountain (440SM, Hi-Lo)	Dual bowl with jug fuller and doggie bowl
Park Area Lighting	Carmanah (SE-20, Solar LED) American Electric Lighting	Consult with District, use pending District approval.
Park Pathway Lighting	FairWeather B-3-L Bollard Light	
Park Name Signs	Outdoor Creations District Standard	Concrete sign for placement in planting area
Park Rule Sign	Aluminum .083 thickness	Color and logo per District Standard and design. Sign to be located in planting area on posts with other signs, or light pole when possible. Mount at 8' minimum.
Picnic Tables	Outdoor Creations Wabash Valley (S-Series) FairWeather (F-8)	
Picnic Table and Chairs	Wabash Valley (CA-300R, Chair) Wabash Valley (CA-101, CA-101R Tables)	For use at Golf Course or Plaza settings, surface mounted, or approved equal

DESIGN & CONSTRUCTION STANDARDS MANUAL: June 2015

	FairWeather (F-7)	
Park Bench with Backrest	Dumor (58, 119, 160) Wabash Valley (HR305, ES 420) Sitescapes (Westport Series Horizontal Strap) Victor Stanley (R-28, CR-138) FairWeather (PL-5,	
Park Bench without Backrest	Dumor (92, 120, 164) Wabash Valley (ES-425) Victor Stanley (Custom Arching Benches) Sitescapes (Westport Series Horizontal Strap) FairWeather (PL-1.5,	
Trash Receptacles	Outdoor Creations Dumor (84) Victor Stanley (SD-42 Surface Mount, NSDC-36, RB-36) FairWeather (TR-1224, TR-12)	All proposed trash receptacles to be reviewed and approved by District on a project by project basis.
Tennis Court Post and Net	Patterson Williams (2205)	3" Square posts, black powder coated, removable brass tension handle, heavy duty net.
Decorative Steel Tube Fencing	Ameristar or approved equal	Color shall be black, unless otherwise directed
Vinyl Coated Chain Link Fencing	Dog Park Applications: 5'-6' tall, black	
Permanent Bollards	FairWeather (42" B-3, 42" B-3-L)	Black, powder coated
Removable Bollard	FairWeather Site Furnishings (42" B-3-R)	District approval required prior to specified use of any removable bollards
Volleyball Posts and Nets	Patterson Williams (2216-00)	3-1/2" O.D. posts, 10-1/2 ft. long with fixed eyelets, or approved equal.
Volleyball Sand	Patterson sand and Gravel, Sheridan, CA (No. 2, fine white)	Or approved equal
Tree Grates	Sitescapes (TerraFirma Series) South Bay Foundry (CNK D04 Series) South Bay Foundry (STBM D22 Series) South Bay Foundry (STB D11 Series) Urban Accessories (KVIA-SQ, Viper) Ironsmith (A.D.A, Market Street Series)	
Skateboard Racks	Madrax (Skateboard Rack System, SRS-SNG-6-P)	
Skateboard Stoppers	Skate Stoppers (HR and FR series)	
Tree Guards	South Bay Foundry (GD-B Style) South Bay Foundry (GD-C Style)	
Trench Drain Covers	Ironsmith (A.D.A, Conquistador, Market Street Series) FairWeather (CNK Series)	

SECTION 9 - RESTROOMS

9.01 General Standards

- A. A proposed restroom location must be shown on Approved Plans for any Community Park site. Proposed restroom locations shall be stubbed out for sewer, potable water and electrical service.
- B. No porcelain or plastic fixtures shall be used. Use stainless steel commercial grade unless otherwise approved.
- C. Install at least one outdoor GFI Quadruple outlet with heavy duty, weather resistant, vandal proof lockable cover
- D. Lighting fixtures shall be rough service, vandal resistant fixtures or approved equal.
- E. A minimum 5-foot wide chase is required.
- F. Prefabricated restroom building manufacturers must meet all applicable California codes and requirements.
- G. Prefabricated restroom building plans must be stamped by a California licensed engineer.

Restroom Fixture Standards

Description	Model #	Manufacturer
Toilet Flush Valves	952-1.5-MBFW	Sloan
Urinal Flush Valves	995-MBFW	Sloan
Toilet	4110 back supply w/A611 access panel	Metcraft
Urinal	7630 back supply w/A610 access panel	Metcraft
Sink	5683 single hole w/A311 faucet & A775 braces	Metcraft
Partitions	Reinforced composite partition	Bobrick
Toilet Paper Dispenser	OFUX2	Vandalstop Products
Toilet Seat Cover Dispenser	SCD	Vandalstop Products
Electric Hand Dryer	XA5	World Hand Dryer
Interior Fluorescent	VSL 2 40 120 ES, Enclosed Linear Flourescent	Lithonia

SECTION 10 - IRRIGATION SYSTEM

10.01 General Standards

- A. All utility equipment shall be mounted on concrete pads. Irrigation equipment and utility boxes shall be installed in planter areas.
- B. Irrigation mainlines shall be designed as a looped system.
- C. Irrigation valve boxes shall not be placed within the playing surface of sports fields or adjacent field safety zone.
- D. Sprinkler head spacing shall be designed to accommodate head-to-head spacing, with no runoff or overspray onto non-irrigated areas.
- E. Sprinkler head layout shall be designed to apply water at a precipitation rate that is compatible with the needs of the plant material irrigated and does not exceed the infiltration rate of the soil.
- F. Any system utilizing recycled water shall be designed and installed in strict compliance with all applicable rules, regulations and laws.
- G. Do not place irrigation within the drip line of any Oak or Heritage Tree canopy.
- H. Designers and Consultants shall comply with AB 1881 the Model Water Efficient Landscape Ordinance. All efforts shall be made to design a water efficient irrigation system.

10.02 Definition of Contractor

The term "Contractor" is used in its broadest sense within this section. The Contractor may be a Developer/Contractor installing public improvements to be turned over to the District for maintenance, the District General Services Department, or Construction Contractors hired on contract by the District.

10.03 Scope of Work

It is the responsibility of the Contractor to complete the installation of the landscape irrigation system as indicated on the Approved Landscape Plans. The Contractor is required to order and furnish all labor, materials, supplies, tools, and transportation, as well as perform all aspects of operations in connection with and reasonably incidental to

the installation of the irrigation system. This work includes, but is not limited to, the following:

- A. Automatic irrigation system; including piping, fittings, sprinkler heads, couplings, adapters, and accessories
- B. Pumps (if indicated on the Approved Landscape Plans)
- C. Remote control valves, gate valves, quick coupler valves
- D. Backflow preventer with enclosure
- E. Water meter (coordinate the installation to be done by others)
- F. Flow sensors (if indicated on the Approved Landscape Plans)
- G. Controller, controller wiring, mounting equipment and enclosure
- H. Testing
- I. System adjustments
- J. Excavation and backfill
- K. Sleeving
- L. Record or As-Built Plans
- M. Provide a one year warranty
- N. Backflow inspection and testing
- O. Approval of local land use authority

Work related to the landscape irrigation system that is necessary to complete the project according to the Approved Landscape Plans, may include:

- A. Earthwork and site grading/sculpting
- B. Concrete/Bomanite installation
- C. Planting
- D. Electrical (power and data lines for the automatic irrigation controller)

10.04 Quality Control

A. CODES AND STANDARDS:

All work and materials shall be in full compliance with codes and standards, including, but not limited to:

1. The rules and regulations of the National Electric Code
2. The rules and regulations of the Uniform Plumbing Code, as published by the Western Plumbing Officials Association
3. All applicable State and local laws, codes, and regulations including the Model Water Efficient Landscape Ordinance (Assembly Bill 1881).

The above-mentioned codes and standards are the minimum level requirements. Nothing in the Approved Landscape Plans is to be construed to permit work not conforming to these codes and standards. If the Approved Landscape Plans call for materials or construction of a better quality or larger size than required by the above mentioned rules and regulations, the provision in the Approved Landscape

Plans shall take precedence. The Contractor is responsible for complying with all applicable rules and regulations, including those not mentioned here or shown on the Approved Landscape Plans. All materials and labor required for compliance shall be furnished by the Contractor, at no additional cost to the District.

B. SAFETY:

1. All work shall be performed in a safe manner and shall meet or exceed the safety standards established under the Federal Occupational Safety and Health Act and its most current amendments.
2. Barricades, guards, warning signs, and lights shall be erected and maintained as required by OSHA regulations, the Property Owner, or by the District for the protection of the public and workers.
3. Where work infringes upon the public right-of-way, traffic control plans shall be submitted and encroachment permits obtained from the local land use authority.

C. PERSONNEL:

1. The Contractor shall possess all proper and current licenses, certificates, permits and/or registrations required to perform the scope of services.
2. The Contractor shall employ at least one qualified supervisor familiar with the products and requirements of this section. The supervisor shall be present at the project at all times. The supervisor shall have full authority to act on behalf of the Contractor.
3. The Contractor shall employ workers familiar with the products and requirements of this section.

D. SITE PROTECTION:

1. The Contractor shall incur all expenses to repair or replace any damage to existing improvements, such as buildings, equipment, irrigation systems, piping, sewers sidewalks, or landscaping caused during activities related to the scope of work in this section. Repairs and replacements must be done in a manner and to a quality level satisfactory to the Owner and District within a reasonable timeframe as determined by the District.
2. The Contractor shall exercise extreme care when excavating and working near existing utilities. The Contractor is responsible for correcting any damage to existing utilities for which the Contractor's operation is either the direct or indirect cause. The Contractor is required to call **Underground**

Service Alert (USA) at (800) 227-2600 for marking of underground utilities prior to excavating.

E. **REVIEWS AND INSPECTIONS.**

The Contractor shall specifically request the following District approvals at the appropriate times and prior to progressing work. The District will decide at the time of the request whether the specific inspection will be required.

Mainline Pressure Test

Upon proper installation of the mainline, the Developer/Contractor shall contact the District, a minimum of three days in advance, to schedule a mainline pressure test. The mainline pressure test is always required.

2. Layout Inspection

Prior to any installation, the exact locations of the major components of the landscape irrigation system shall be flagged and/or staked. This should include at a minimum the piping, sprinkler heads, valves, control wire, backflow prevention units, controllers, and weather stations. Once marked, the Contractor shall notify the District to schedule an inspection for approval of the layout of the project.

- 3. Lateral Line Pressure Test
- 4. Coverage Test
- 5. Substantial Completion Inspection
- 6. Final Acceptance and Warranty

10.05 Submittals

A. MATERIALS

A list with information and descriptions of any components and materials to be used that are not specified on the Reviewed Landscape Plans shall be submitted to the District for approval. All materials must be deemed acceptable by the District prior to any work being performed.

Description	Manufacturer	Model Number
Irrigation Controller	Rainbird	ESP-MC Satellite
Controller Enclosure	ALLSPEC	BFE-4230
Master Valve	Superior	3100-05 N/O
Flow Sensor	Rainbird	F-S-350 B (high flow) F-S-150 P (low flow)
Backflow Prevention Device	Febco	860 or 880 Reduced Pressure Assembly

Remote Control Valve	Rainbird	PEBPPRS-D Series
Gate Valve 3" Smaller	NIBCO	T-113 Class 125
Gate Valve 4" Larger	Stockham	G612
Drip Irrigation	Rainbird	XF-XDI Series
Turf Irrigation Rotors	Rainbird	5000/5500 Series or 8005 for larger installations
Spray Head Irrigation Body	Rainbird	1800 Series
Rotary Nozzle Irrigation Heads	Rainbird	R13-18 Series R17-24 Series
Rotary Nozzle Irrigation Heads	Hunter	MP Rotator Series
Root Watering System Bubblers	Rainbird	RWS-B-C-1402, with filter fabric sock
Quick Coupler Valves	Rainbird	Model 44LRC
Booster Pump Package	Custom Pump and Power	Designed for each site based on requirements needed.

B. SUBSTITUTIONS:

The District must approve any substitutions to the specifications of the Approved Landscape Plans and to the accepted list of materials. All substitutions must be of equal or greater quality than that specified. Requests for substitution must be accompanied by a copy of catalogue information on the materials desired for substitution. No substitutions will be permitted without prior written consent from the District. Unapproved substitutions shall be corrected for compliance at no cost to the District.

C. RECORD OR AS-BUILT DRAWINGS:

The Contractor shall maintain in the field office one complete set of the Approved Landscape Plans. Throughout installation of the landscape irrigation system, records shall be updated showing the exact locations of all the components of the system. If site conditions require modifications to the Approved Landscape Plans, the Contractor must first receive written authorization from the District. The Contractor shall then update the field-maintained Landscape Plans. Any work not installed as indicated on the Approved Landscape Plans that did not receive prior District approval constitutes an unauthorized change and shall be corrected by the Contractor at no cost to the District. The field-maintained Landscape Plans must also indicate the locations and dimensions of all underground electrical features, including stub-outs for future valves and connections. Locations on all As-Built Plans shall be made in reference to two permanent site features.

Included with the As-Built Irrigation Drawings shall be a water budget which includes estimated annual water use in gallons, the area in square feet to be

irrigated, precipitation rates for each valve circuit, a monthly irrigation schedule for plant establishment, and an irrigation schedule for establishing plantings. Irrigation scheduling shall consider ETO rates and tied into a local weather station network.

Upon completion of the project, the Contractor shall obtain reproducible prints from the Landscape Architect and neatly correct the prints to show all of the as-built conditions. The Contractor shall submit the As-Built Plans to the District, which must be done before the District will accept the project.

OPERATION AND MAINTENANCE MANUALS:

Prior to the final inspection of the landscape irrigation system, the Contractor shall furnish two individually bound service manuals to the District. The manuals should contain the following:

1. An index sheet indicating the contact information of the Contractor. This includes at minimum the name, telephone number, professional license number, email address and physical address.
2. A copy of the signed and completed Irrigation Warranty form.
3. A certificate of insurance verifying coverage for completed operations.
4. A list of equipment installed, with the manufacturer's contact information
5. Copies of installed equipment warranties and certificates.
6. Complete operating and maintenance instructions of all installed equipment. This should include the name of the manufacturer, the model number, exploded drawings, and a parts list.
7. The contractor shall also provide the District with instructions for operation of the landscape irrigation system as a whole.

E. HARDWARE ITEMS:

Provide the District with the following hardware items:

1. Two sets of matching QCV (quick coupler valve) keys and hose swivels.
2. Two keys to each controller box.
3. Two sets of any special tool required for the maintenance of any component of the landscape irrigation system.

10.06 Pipes and Fittings

A. PVC PIPE AND FITTINGS:

1. Main lines under constant pressure shall be polyvinyl chloride (PVC) 1120-315 psi for 2 ½" outside diameter and larger, and PVC 1120 Schedule 40 for 2" outside diameter and less in size.
2. At changes in direction or branch mains, use appropriate Schedule 40, Type I, Grade I PVC fittings as approved by the Uniform Plumbing Code.
3. Lateral lines not under constant pressure and protective sleeves shall be (PVC) 1120-315 psi for 2 ½" outside diameter and larger, and PVC 1120 Schedule 40 for 2" outside diameter and less in size, Type I, Grade I PVC solvent weld fittings.
4. Connections between main lines and remote control valves (RCV's) shall be Schedule 80 PVC (threaded both ends) nipples and fittings.
5. Risers shall be Schedule 80 PVC threaded nipples and Schedule 80 PVC ells, as indicated on the District-Reviewed Landscape Plans.

B. COPPER PIPE AND FITTINGS:

1. Copper pipe shall be Type K, hard tempered ASTM B88 and fittings shall be wrought solder joint type in accordance with ANSI B16.22.
2. Joints shall be soldered with silver solder, conforming to ASTM B206.

C. BRASS PIPE AND FITTINGS:

1. Brass pipe shall be 85% red brass ANSI Schedule 40 screwed pipe.
2. Fittings shall be 125 pound class medium brass screw-type.

D. GALVANIZED STEEL PIPE AND FITTINGS:

Galvanized steel pipe and fittings are generally NOT allowed. Should the use of galvanized steel pipe and fittings be necessary, prior written approval must be received from the District. Underground galvanized pipe installations will not be permitted under any circumstances.

10.07 Reduced Pressure Backflow Preventer

- A. Reduced Pressure Backflow Preventer shall be a Febco 860 or 880 Reduced Pressure Assembly, or approved equal. The units shall be equipped with ball valves and the manufacturer and model number shall be specified on the Landscape Plans. The

District will review the specification when the Landscape Plans are submitted for review.

- B. Backflow prevention units shall be contained within a steel vandal-resistant enclosure. Chain link is not approved by the District.

10.08 Booster Pumps

- A. The Landscape Architect/Irrigation Designer shall submit all manufacturer supplied data on all pumps. The manufacturer and model number shall be specified on the Landscape Plans. Booster pump information will be reviewed when the Landscape Plans are submitted for review.
- B. Booster pumps, points of connection, and all related irrigation system components shall be sized to complete an entire irrigation cycle within a 7-hour window whenever possible. The watering window should be from 10 pm to 5 am.
- C. All pumps shall have a flow-switch activation assembly and the proper motor size to ensure efficient operation.
- D. All pumps shall be protected by a low-pressure inlet-sensing device.
- E. All pipe and fittings within the pump assembly shall be made of brass.
- F. All pumps shall be contained within a steel or masonry vandal-resistant enclosure. Chain link is not approved by the District. Enclosure shall safeguard against excessive sound attenuation.
- G. Pump assemblies located adjacent to a wall shall be installed in a manner that provides clearance for servicing the assembly.

10.09 Master Valve and Flow Sensor

- A. Master Valve shall be Superior Model # 3100-05 N-O.
- B. Flow Sensor shall be Rainbird F-S-350 B (High Flow) or F-S-150 P (Low Flow).

10.10 Moisture Sensor

The District generally discourages the use of moisture sensors, in favor of other sensing devices such as a weather station linked to a central controlled system.

10.11 Remote Control Valves

- A. Remote control valves shall be Rainbird PEB and PRS-D Series, or an equal approved by the District. Sizes of remote control valves shall be specified on the Landscape Plans and on the As-Built Plans.
- B. Valves and circuits shall be installed independently based on hydro-zone watering requirements.
- C. Remote control valves shall have Schedule 80 unions on either side of installation.
- D. Irrigation valves shall be designated and zoned by function, example: soccer field, turf valved separately from open play area turf, ect.

10.12 Valve Boxes

- A. Valve boxes shall be Rainbird VB-JBM (Jumbo Box) or an approved equal. A lid is required and both the box and lid shall be plastic. The top of box rim and lid shall both be heat stamped with the controller designation and station number and be marked "IRRIGATION CONTROL VALVE" by the Contractor.
- B. All valve boxes shall be placed in a geotextile fabric envelope per District standard.

10.13 Automatic Irrigation Controller

- A. CENTRAL CONTROLLED IRRIGATION SYSTEMS:

District maintained areas that are required to install a central controlled irrigation system controller shall conform to the following general requirements:

- 1. Automatic irrigation controllers for District maintained irrigation systems shall be Rain Bird Maxicom ESP-MC Satellite (District Central Control System). A dedicated mainline with the appropriate master valve(s) and flow sensor(s) shall be provided by the Contractor as listed on the District-Reviewed Landscape Plans.
- 2. Additional conduit wiring shall be installed with Controller for centralized control system, per manufacturer's and telephone company specifications.
- 3. ESP-LXMC – Standard Fld. Wire and ESP-LXD – 2 wire decoder for IQ Central Control System

10.14 Automatic Irrigation Controller Wiring

- A. The wiring for the irrigation controller shall be copper with UL approval for direct ground burial. The wire size shall be #14-1.
- B. The common ground wire shall have a white insulating jacket. The control wire shall have an insulating jacket of a color other than white.
- C. Splices shall be made with a 3M DBY splice kit or an approved equal. A separate ground wire is required for each controller.
- D. Control wires shall be connected to irrigation controller in a sequential arrangement according to the assigned identification number of each valve as shown on the Approved Landscape Plans.

10.15 Weather Station

The Landscape Architect/Irrigation Designer shall contact the District prior to submitting any plans for approval for information regarding new installation or connection to the existing District weather station at Hagan Park for use in conjunction with the Rainbird Maxi-com Central Control System.

10.16 Gate Valves

- A. Gate valves 3 inches and smaller in size shall have bronze bodies and rising stems and brass cross handles. Gate valves of this size shall be threaded and be a Nibco T-113 Class 125 Brass body, or an approved equal.
- B. Gate valves 4 inches or larger shall be AWWA approved and have flanged connections, a 2-inch square operating nut, cast iron bodies, and have an arrow cast in the metal indicating the direction of the water flow. Gate valves of this size shall be Stockham G612 or approved equal.
- C. Gate Valves shall be installed in Rainbird VB-JBM (Jumbo Box) with cover with locking lid. The top of box rim and lid shall both be heat stamped and marked "IRRIGATION GATE VALVE" by the Contractor.

10.17 Sprinkler Heads

- A. GENERAL:

1. The District does not permit irrigation runoff or overspray into non-irrigated area.
2. Sprinkler system shall be designed to apply water at a precipitation rate that is compatible with the needs of the plant material irrigated and does not exceed the infiltration rate of the soil.
3. The GPM flow rate for the number of heads designated per valve shall not exceed 70% of the maximum flow rate of the Backflow Prevention Device as measured on the downstream side of the device.

B. LARGE TURF AND GROUNDCOVER SPRINKLER HEADS:

1. For large turf and groundcover areas, sprinkler heads shall be gear-driven and pop-up type with integral check valve. The body shall be constructed with 3/4-inch or 1-inch N.P.T. bottom inlet. The sprinkler head shall have positive spring retraction and rise or pop-up a minimum of 6 inches for turf and 12 inches for groundcover. The District requires use of Rain Bird 5000, 5500 or 8005 Series, or District written-approved equal.
2. The District does not permit the use of impact drive pop-up type sprinklers in favor of the above detailed gear-driven pop-up style sprinkler heads for water conservation reasons. Sprinkler heads of this type in turf areas shall have a protective rubber cover.
3. All sprinklers must have head-to-head coverage with spacing no greater than 45' feet apart unless written approval is granted by District.
4. Full and partial circle rotary sprinklers shall be valved separately unless rotary nozzles are designed for matched precipitation.

C. SMALL TURF AND GROUNDCOVER SPRINKLER HEADS:

1. For small turf and groundcover areas, sprinkler heads shall be Rain Bird 1800 Series with Hunter MP Rotary Nozzle or an approved equal.
2. All heads shall rise or pop-up a minimum of 6 inches in turf areas and 12 inches in groundcover areas where the plants specified on the Landscape Plans may mature to block the water spray.
3. All sprinklers must have head-to-head coverage.
4. Full and partial circle rotary sprinklers shall have matched precipitation rates.

10.18 Drip Irrigation

- A. Per the Model Water Efficient Landscape Ordinance (AB 1881), drip irrigation shall be used for shrubs, groundcover and turf in planter areas less than 8' wide. Tree bubblers shall be used for trees. The Designer and Contractor shall make every attempt to minimize the use of planter areas that are less than 8' wide (with exception to tree wells).
- B. Drip irrigation shall be Rainbird XF-SDI Series Subsurface Dripline or approved equal.
- C. Filter shall be a Rainbird QKCHK Series and shall be installed inside a Rainbird VB-JBM (Jumbo Box).
- D. Pressure regulator shall be a Rainbird PSI-M40X-100 or approved equal. Pressure regulator shall be located inside a Rainbird VB-JBM (Jumbo Box) or an approved equal.
- E. Rainbird MDFCOUP Couplings and MDCFCAP Removable Flush Caps are required at all ends of long drip bubbler runs or as shown on irrigation drawings. Couplings and Removable Flush Caps shall be installed inside a Rainbird VB-10RND box or an approved equal.
- F. All trees shall be irrigated by (2) Rainbird Root Watering System Bubblers RWS-B-C-1402 with filter fabric sock per tree and root watering system bubbles shall not exceed .75 gallons per minute.

10.19 Quick Coupler Valves

- C. Quick Coupler Valves shall be Rainbird 44LRC or an approved equal.
- D. Quick Coupler Valves shall be installed inside a Rainbird VB-10RND box or an approved equal.

10.20 Equipment Enclosures

All equipment enclosures for controllers, pumps, backflow preventers, and other miscellaneous equipment shall be CRPD approved Strong Box MPE Series. Stainless steel enclosures shall not be painted.

10.21 Miscellaneous Equipment

The Contractor shall provide and incur all costs for all equipment called for in the Approved Landscape Plans and as approved by the District.

10.22 Miscellaneous Installation Materials

The proper assembly of an irrigation system requires the use of other materials, including solvent cement, primer, joint sealer, Teflon tape, copper solder and flux, and wire connectors. All such products shall be used in strict accordance with the manufacturer's directions and recommendations.

- A. Solvent cement and primer for solvent weld joints shall be of a make and type approved by the manufacturer of the pipe and fittings. The cement shall be maintained at the proper consistency throughout its use.
- B. Lubricant for assembling rubber ring seal joints shall be of a make and type approved by the manufacturers of the pipe and fittings
- C. Pipe joint compound shall be non-hardening and non-toxic and designed for use on threaded connections in water carrying pipe. The joint compound shall be Lasco Blue Pipe Thread Sealant or an approved equal.

10.23 Execution

The following provides the standards the Contractor shall follow in the execution of the installation of the landscape irrigation system as set forth in the Approved Landscape Plans. The Contractor shall also refer to the DETAILS section and install all specified assemblies in accordance with the details shown therein.

10.24 General Installation

- A. The landscape irrigation system shall be installed by a licensed landscape contractor and shall be in full accordance with all applicable state and local laws, codes and standards.
- B. The Contractor shall follow all manufacturer's directions and recommendations, unless otherwise indicated on the Approved Landscape Plans. However, in no instance shall this be construed as permission to violate any state or local law, code, or ordinance and nothing shall be done in a manner that nullifies a manufacturer's warranty.

10.25 Site Conditions

- A. All scaled dimensions on the Approved Landscape Plans are to be considered approximate. The Contractor shall check the specifications list and verify all size dimensions prior to proceeding with any work.
- B. Installation of all irrigation material and equipment, especially pipe, shall be coordinated in a manner that does not interfere with any utilities, future/other construction or lead to difficulty in planting trees, shrubs, turf or groundcover.
- C. The Contractor shall avoid trenching within the dripline of trees whenever possible. When not possible, all damaged roots 1-1/2 inches and larger in diameter shall be cut leaving a clean face. Immediately after cutting the root, the face is to be treated with tree seal, the required irrigation components are to be installed, and the applicable trench section is to be back filled and soaked with water. However, no fittings shall be covered by such backfill until after the District inspection. The Contractor shall follow these actions immediately in order to safeguard the health of the tree. Notify the District of any above mentioned root damage and report procedure used to correct damage.
- D. All grades are to be checked carefully to ensure safety in the installation of the landscape irrigation system.
- E. The Contractor shall coordinate any work to be done by others that affects the landscape irrigation system, such as the location of pipe sleeves through walls or under any paving.
- F. The Contractor shall verify the available water pressure and flow rate prior to construction. If deficiencies exist that will hinder the system's performance, the District is to be contacted immediately for direction.
- G. The Drawing design is considered diagrammatic. All piping, valves, etc. shown within the paved areas are for design clarification only. All piping, valves, etc. are to be installed in planting areas only

10.26 Project Coordination

A. SEQUENCING AND SCHEDULING:

The Contractor shall be aware of the full scope of the project. As such, the Contractor is responsible for the coordination of the installation of the landscape irrigation system with other site improvements, existing utilities and utility installations, plant materials installation, and any other work required for the completion of the project

B. ENVIRONMENTAL CONDITIONS:

Site work such as trenching and backfilling shall not be performed during wet, muddy, or frozen conditions.

10.27 Protection of Improvements and Materials

- A. The Contractor shall protect all work from damage for the duration of the contract. This includes work done by others. The Contractor shall also protect all materials as directed by the manufacturers. This includes protecting plastic pipe and fittings from direct sunlight, and from undue bending and external loading. The bed on which the pipe is stored is required to be the full length of the pipe. Any damaged pipe or fittings shall not be used under any circumstances.
- B. The Contractor shall take all necessary precautions to protect all site conditions improvements, and plant materials that are to remain. Should the Contractor cause any damage, the Contractor shall make repairs to restore to original condition or furnish and install equal replacements.
- C. All existing irrigation systems shall be maintained in operating condition at all times. The Contractor is responsible for immediate repair of any damage to existing irrigation systems. Should repairs be made, the Contractor shall remove all sprinkler heads on applicable zones and flush the system of any dirt or debris before re-installing the sprinkler heads.

10.28 Correction of Work

Any and all discrepancies of work the District deems unsatisfactory shall be corrected by the Contractor at no additional cost to the District. The correction of such work shall be completed within a reasonable time frame determined by the District.

10.29 Trenching

- A. The trench shall be dug straight and in a manner that supports the pipe continuously on the bottom of the trench. The pipe shall be laid on an even grade. The trenching excavation shall follow the layout shown on the Approved Landscape Plans and which was field inspected and approved by the District.
- B. Main lines shall have 4" of sand bed and 4" of sand cover. Total soil coverage shall be 24" over top of pipe.
- C. Lateral lines to spray sprinkler heads shall be provided with a minimum of 18 inches of cover over top of pipe.

- D. All control wiring shall be provided with a minimum of 24 inches of cover.
- E. Any pipe and/or wiring located under asphalt or concrete pavement shall be provided with a minimum of 36 inches of cover from finished grade, or be 12 inches below sub-grade, whichever is lower.
- F. Trenches shall not be backfilled until all required tests and inspections are performed.

10.30 Installation and Testing of Main Line and Lateral Lines

A. MAIN LINE:

The Contractor shall install the main line as indicated on the Approved Landscape Plans and in accordance with the manufacturer's directions and these Landscape Standards. Once installed, the Contractor shall adhere to the following steps required for testing before any further work is performed:

1. Install the main line, all fittings for connection to the lateral lines, and other components that join directly to the main line such as the backflow prevention unit, Reduced Pressure Backflow Preventer, remote control valves gate valves, quick coupler valves, and booster pumps.
2. Main lines shall have 4" of sand bed and 4" of sand cover. Total soil coverage shall be 24" over top of pipe.
3. Contact the District a minimum of three working days in advance to schedule an appointment for a main line pressure test.
4. Cap all openings in the line.
5. Place small sections of backfill over the line to prevent slipping, arching, or other movement when the line is under pressure. No fittings shall be covered by such backfill.
6. Testing of pressure main lines shall be done prior to the installation of electric control valves.
7. During District inspection and testing, the Contractor shall perform ASTM F-690 testing as follows:
 - a. Solvent welded PVC joints shall have cured a minimum of four hours or longer if required by manufacturer's directions. The Contractor shall adhere to all other manufacturer's directions.
 - b. Slowly fill the pipe with water to avoid water hammer damage.

- c. Bleed the line to remove all air from the pipe.
- d. Using a hydraulic pump or other safe method (do not use an air compressor), pressurize the line to 125% of the designed operating pressure.
- e. After two hours of maintaining the above pressure, the line will then be inspected for leaks or other problems while the system continues to hold the above pressure.
- f. The Contractor shall be responsible for correcting any inadequacies, deviations from the Approved Landscape Plans, or any other problems found by the District. Corrections will be made at no cost to the District. Any faulty joint shall be completely rebuilt. The use of any cement or caulking to seal a leak is strictly prohibited. After all corrections are made, the Contractor shall again notify the District to schedule an appointment for a re-inspection.
- g. The Contractor may proceed with installation of the lateral lines only after the main line passes inspection.

B. LATERAL LINES:

The lateral lines shall only be installed after the main line has passed inspection and testing:

1. Lateral lines shall be installed in a manner that will not damage the main line.
2. Lateral lines and irrigation heads shall be laid following grade contours.
3. Lateral lines shall have 4" of sand bed and 4" of sand cover. Total soil coverage shall be 18" over top of pipe.
4. The pipe shall be filled with water slowly to avoid water hammer damage.
5. The system shall be visually inspected for leaks at normal line pressure after installation is complete. Any faulty joint shall be completely rebuilt. The use of any cement or caulking to seal a leak is strictly prohibited. Make any needed corrections prior to scheduling the system inspection with the District.

10.31 PVC Pipe and Fitting Installation and Connections

- A. Multiple assemblies shall not be installed on plastic lines or lateral lines. Each assembly shall be provided with its own outlet.
- B. PVC pipe and fittings shall be thoroughly cleaned to remove any dirt dust moisture or other foreign matter before installation.
- C. SOLVENT WELDING PVC pipe and fittings are to be joined using solvent welding. This method is to be performed in accordance with the indications supplied by the primer, solvent cement, pipe, and fitting manufacturers. Generally, the method is as follows:

1. The joint is to be made by first squaring and deburring the end of the pipe. The pipe is to then be cleaned again to remove any dirt, dust, moisture, or other foreign matter.
2. Dry fit the pipe to ensure it inserts 1/3 to 2/3 of the depth of the socket.
3. To join the pipe with the fitting, first coat both the outside (male end) of the pipe and the inside (female) part of the fitting socket with an approved primer, such as Weld-On P-70 Primer. Without delay, apply an approved solvent cement, such as Weld-On 711 Cement liberally to the male end of the pipe. Also, apply a light coating of cement to the female part of the fitting socket, followed by a second coating to the male end of the pipe.

Immediately insert the pipe into the fitting and turn the pipe 1/4 turn to properly seat the pipe, distribute the cement evenly, and remove any air bubbles. The pipe must seat to the bottom of the socket and be aligned properly to avoid undue strain to either the pipe or the fitting.

5. The joint should be held still and in place for a minimum of 30 seconds.
6. Wipe any excess cement from the pipe and fitting.
7. Allow the joint to cure for a minimum of 30 minutes before handling and a minimum of 4 hours before allowing water into the pipe.

D. THREADED JOINTS:

Where threaded joints are to be used, such as the riser connector to the sprinkler head, the Contractor shall adhere to the following:

1. Only factory formed threads are permitted. Field threading of plastic pipe will not be permitted under any circumstance.
2. All threaded plastic joints shall be treated with threaded joint sealant compound. The compound must be approved by the District for use on plastic pipe. The compound should be applied to the male end of the pipe only. Adhere to all applicable manufacturers' directions.

3. Align and tighten the pipe and fittings to properly engage threads. Caution must be exercised to not strip the threads.
 4. Final tightening of the threaded joint shall be done with a strap-type wrench. Under no circumstance shall wrenches with metal jaws be used on plastic pipe and fittings. Do not over-tighten and strip the threads. Wrench tightening shall not rotate the joint more than one full turn beyond that of hand tightening.
- E. During assembly and installation of the pipe and fittings, all openings shall be capped to prevent dirt or other debris from entering the assembly creating an obstruction and reduced system performance. Caps and plugs shall only be removed when necessary to continue assembly.
- F. PVC pipe shall be installed in the trench with moderate "snaking" from side to side to allow for expansion and contraction. The pipe shall not be installed when the air temperature is below 40° Fahrenheit.

10.32 Copper Pipe and Fitting Installation and Connections

A. SOLDERING:

Copper pipe and fittings shall be joined using silver solder conforming to ASTM B206. All directions by the pipe, fitting flux, and solder manufacturers shall be followed. Generally soldering is as follows:

1. Copper is a soft metal and caution shall be exercised to not pinch or crimp the pipe or the fittings.
2. The pipe end shall be cut square using a wheel-type cutter. Do not apply excessive pressure that may damage the pipe. Cutters of other types are not permitted.
3. The pipe and fittings should first be cleaned to remove dirt dust, moisture or other foreign matter before beginning.
4. The fresh cut on the male end shall have any burrs or other extraneous materials removed.
5. The male end of the pipe and the female fitting socket shall be cleaned/polished with an emery cloth to remove any oxidation or residuals that can hinder the soldering process.
6. Wipe the polished areas with a clean cloth and take care to not touch these areas with bare hands as the oils in the hand can also inhibit the soldering process.
7. Apply flux to the male end of the pipe and the female fitting socket. Be sure to follow the manufacturer's directions. Application of flux is required as it helps the solder to be drawn into and bond the joint properly.
8. The pipe should be firmly inserted into the fitting and given a 1/4 turn.
9. Using the appropriate type of torch, the joint should be heated uniformly. Proper temperature is achieved when the solder is put into contact with the joint and the solder melts and is drawn into the joint forming an even bead along the outer edge of the joint.
10. Once cooled the joint is to be wiped clean and inspected to ensure proper solder fill and bonding.
11. The joint shall be allowed to cool completely before being handled and permitted to have water in the line. Do not attempt to aid the cooling process, as this will deteriorate the quality of the joint.

B. THREADED JOINTS:

Should the District grant permission for the use of threaded joints in copper pipe and fitting assemblies, the Contractor shall adhere to the following:

1. All connections to threaded fittings shall be done using factory produced adapters only. Copper pipe may be field threaded only when absolutely necessary. Field threading shall be done accurately on the proper axis and done utilizing a sharp die. Any adapters are to be soldered to the non-threaded end of the assemblies (refer to above section on soldering).
 2. All threaded copper joints shall be treated with threaded joint sealant compound. The compound must be approved by the District for use on copper pipe. The compound should be applied to the male end of the pipe only. Adhere to all applicable manufacturers' directions.
 3. Align and tighten the pipe and fittings to properly engage the threads. Caution must be exercised to not strip the threads.
 4. Final tightening of the threaded joint shall be done with a strap-type wrench. Under no circumstance shall wrenches with metal jaws be used on copper pipe and fittings. Do not over-tighten and strip the threads. Wrench tightening shall not rotate the joint more than one full turn beyond that of hand tightening.
- C. During assembly and installation of the pipe and fittings, all openings shall be capped to prevent dirt or other debris from entering the assembly creating an obstruction and reduced system performance. Caps and plugs shall only be removed when necessary to continue assembly.

10.33 Brass and Galvanized Steel Pipe and Fitting Installation and Connections

The District does not generally permit the use of galvanized steel pipe and fittings. When permitted for use, both brass and galvanized steel joints are to be connected using threaded screw joints. The method for connecting threaded joints is as follows:

- A. Field threading should be done only when absolutely necessary. Field threading shall be done accurately on the proper axis and done utilizing a sharp die.
- B. All threaded joints shall be treated with threaded joint sealant compound. The compound must be approved by the District for use on the appropriate pipe. The compound should be applied to the male end of the pipe only. Adhere to all applicable manufacturers' directions.
- C. Align and tighten the pipe and fittings to properly engage the threads. Caution must be exercised to not strip the threads.

- D. Final tightening of brass threaded joints shall be done with a strap-type wrench. Under no circumstance shall wrenches with metal jaws be used on brass pipe and fittings. Metal jaw wrenches are permitted for use on galvanized steel pipe and fittings only. Do not over-tighten and strip the threads. Wrench tightening shall not rotate the joint more than one full turn beyond that of hand tightening.
- E. During assembly and installation of the pipe and fittings, all openings shall be capped to prevent dirt or other debris from entering the assembly creating an obstruction and reduced performance. Caps and plugs shall only be removed when necessary to continue assembly.

10.34 Rubber Ring Seal Joint

When approved for use by the District, rubber or gasket seal joints should be assembled according to the manufacturer's directions. Mechanical or Flange Restraints shall be provided with the use of rubber ring seal joints.

A. RUBBER RING SEAL JOINT:

1. Factory produced male ends should be used whenever possible. All male ends made in the field shall match exact factory specifications.
2. Carefully clean the bell or coupling to remove any dirt, dust, moisture, or other foreign matter. Proper cleaning is necessary to ensure a proper seal.
3. Carefully insert and position the ring seal or gasket without applying lubricant following the directions of the manufacturer.
4. Lubricate the male end according to manufacturer's directions. Insert the male end as specified to the required depth. When inserting PVC pipe, do so by hand only and not with the aid of any tools.
5. Complete the joint with the installation of the proper coupling.

B. Mechanical / Flange Restraints:

1. Mechanical / Flange Restraints shall be provided at every change of direction in the main line pipe and at every in-line valve to resist system pressure force.
2. Mechanical / Flange Restraints with the size determined by a soil safe bearing of 700 pounds per square foot load and in accordance with the manufacturer's minimum recommendations to withstand the maximum surge pressure against the soil type in which it is installed.

10.35 Backflow Prevention Units

The backflow prevention unit shall be carefully installed according to the manufacturer's directions between the water source and the irrigation system main line. Placement of the backflow prevention unit shall leave adequate spacing for the installation of a lockable-insulated enclosure, to allow easy access for maintenance purposes, and lightly screened by landscape planting. The unit will be inspected by the District as part of the main line test and inspection.

10.36 Reduced Pressure Backflow Preventer Assembly

The pressure vacuum breaker assembly shall be installed according to the manufacturer's directions and will be inspected by the District as part of the main line test and inspection.

10.37 Booster Pump

- A. Booster pumps installations are required at all District maintained parks to increase the existing pressure, the booster pump shall be installed on the main line according to the manufacturer's directions and will be inspected by the District as part of the main line test and inspection.
- B. Irrigation systems shall be designed and installed to complete an entire irrigation cycle within 7-hours whenever possible. Watering shall be schedule to take place between the hours of 10 PM and 5 AM.

10.38 Master Valve and Flow Sensor

Central controlled irrigation systems shall include the appropriate master valve(s) and flow sensor(s) or combination units. Units shall be installed in accordance with manufacturer's directions.

10.39 Remote Control Valves and Valve Boxes

- A. Remote control valves shall be installed as indicated on the Approved Landscape Plans and grouped together whenever practical.

- B. Remote control valves shall be properly placed and with adequate spacing as follows:
 - 1. Valve boxes shall be provided for all remote control valves. Each valve box shall contain only one remote control valve, without exception.
 - 2. Locate valve boxes 12 inches away from and perpendicular to walkway edges, buildings and walls
 - 3. Locate grouped valve boxes 12 inches apart and align the sides parallel to each other.
 - 4. All valve boxes located near turf areas shall be located outside of play areas.
 - 5. Whenever possible, all valve boxes shall be located in shrub/groundcover areas.
 - 6. All valve boxes shall be heat stamped with the controller and station designation and be marked "IRRIGATION CONTROL VALVE."
- C. After passing the main line pressure test, thoroughly flush the main line before installing any valves.

10.40 Automatic Irrigation Controller Wiring

- A. CENTRAL CONTROLLED IRRIGATION SYSTEMS:
 - 1. System design shall include provision of telephone service to central control unit.
 - 2. Irrigation equipment and utility boxes shall be installed in planter areas and where possible shall be lightly screened with plant materials.

Contractor shall conform to all applicable automatic irrigation controller wiring standards detailed for non-central controlled systems.

- B. NON-CENTRAL CONTROLLED IRRIGATION SYSTEMS:
 - 1. When possible, the automatic controller wiring shall follow the same route as the pressure supply or lateral lines and it shall be located within the same trench. When not possible, the automatic controller wiring shall be housed in PVC conduit, Sleeves and Conduits.
 - 2. If more than one wire is to occupy the same trench, the wires shall be taped together or tied with cable ties at 10-foot intervals.

3. Expansion coils shall be provided. Expansion coils shall be formed by wrapping the required length around a 2-inch diameter pipe and then withdrawing the pipe. Requirements for expansion coils are as follows:
 - a. Provide a 3 foot expansion coil at each point of wire connection.
 - b. For wire runs greater than 100 feet in length, a 3-foot expansion coil shall be provided at each interval of 100 feet.
4. Splicing is only permitted on runs exceeding 2,500 feet. All splices shall be placed inside junction boxes with their exact locations shown on the As-Built Plans.
5. Connections shall be made by crimping the bare wire over a brass connector and sealing the connection with an epoxy resin sealer pack.
6. One spare wire of a color other than white shall be installed along the entire length of the mainline, running from the valve boxes to the automatic controller, for every 12 remote control valves. A minimum of 1 spare wire shall be installed if the project has fewer than 12 valves.
7. At each valve and at the automatic irrigation controller the automatic irrigation controller wiring shall be labeled with a 2 1/4-inch X 2 3/4-inch polyurethane identification tag. The identification tag shall indicate the controller number and that valve's station number. The identification tag shall be attached to the controller wire.

10.41 Sleeves and Conduits

- A. Sleeves for Irrigation shall be twice the diameter of the irrigation line and shall be a minimum of schedule 40. A spare 3" sleeve, capped at both ends, shall also be provided adjacent.
- B. Sleeves shall be marked with a ball marker.
- C. Sleeves and conduits are required for all wiring and irrigation line runs under any of the following conditions:
 1. For all flow sensor cables of a central controlled irrigation system.
 2. When the automatic irrigation controller wiring is not located in the same trench and along the same route as a pressure supply or lateral line.
 3. When the automatic irrigation controller wiring passes under hardscape such as an area that is to be paved with concrete, asphalt and/or brick pavers.

4. For any exposed automatic irrigation controller wiring that will not be sheltered by any other means.

All sleeves and conduits shall meet the following requirements:

1. All underground sleeves and conduits shall be Schedule 40 PVC pipe and sized to allow for ample room to maneuver inserts.
2. Flow sensor cables of a central controlled irrigation system shall be run in 1-inch Schedule 40 PVC from the flow sensor to the automatic irrigation controller enclosure.
3. Underground sleeves and conduits shall extend a minimum of 12 inches beyond the edge of paved areas and curbs. Mark horizontal edge of pavement with blue paint to indicate sleeve location.
4. Sleeve and conduit openings shall be provided with removable non-decaying plugs to prevent the entrance of earth and other debris.

10.42 Automatic Irrigation Controller

Automatic irrigation controllers shall be installed as indicated on the Approved Landscape Plans. The exact location for mounting the controller will be determined by the District at the site.

- A. The Contractor shall provide and install any additional equipment, materials, and labor needed for the installation and connection of the automatic irrigation controller, which may include electrical outlets, wiring, conduits, and sleeves.
- B. The automatic irrigation controller shall be connected to a 120-volt disconnect switch and outlet that is located reasonably nearby for ease of maintenance.
- C. The control wires shall be connected to the automatic irrigation controller in a sequential arrangement according to the assigned identification number of each valve as shown on the Approved Landscape Plans.
- D. A complete irrigation schedule outlining water timing per valve, by month, for a twelve month period, shall be provided as part of the construction documents.

10.43 Gate Valves

Gate valves shall be installed as indicated on the Approved Landscape Plans. Gate valves shall be installed according to the manufacturer's directions.

10.44 Sprinkler Heads

- A. Sprinkler heads shall be located as indicated on the Approved Landscape Plans.
- B. The line shall be thoroughly flushed before installing any sprinkler heads or quick coupler valves.
- C. All manufacturer directions for installation shall be followed.

10.45 Equipment Enclosures

All equipment enclosures shall be installed according to the manufacturer's directions.

10.46 Adjustments and Corrections to the Irrigation System

The following adjustments shall be made in preparation for testing and to ensure optimum performance of the landscape irrigation system:

- A. All sprinkler heads shall be flushed and cleaned. Disassembly of the sprinkler head may be necessary.
- B. Sprinkler heads shall be adjusted for proper distribution, direction, and trim to eliminate over-spray or runoff onto walkways, roadways, buildings, and other areas not intended for irrigation during normal operation. Repeat cycles shall be programmed if the problems cannot be corrected with other adjustments.
- C. The Contractor shall determine if coverage is adequate and shall inspect the system and notify the District if any changes are required for proper coverage, such as changes in nozzle size or degrees of arc of sprinkler heads. All changes must be approved by the District and noted by the Contractor on the As-Built Plans.
- D. With the system under pressure, all joints shall be visually inspected for leaks. Any faulty joint shall be completely rebuilt. The use of any cement or caulking to seal a leak is strictly prohibited.
- E. Upon completion the irrigation controller shall be adjusted to provide the minimal amount of water required to sustain healthy plant growth based on E.T. data supplied by District weather station. At no time shall a valve be programmed so that the precipitation rate of the sprinklers exceeds the infiltration rate of the soil causing excessive ponding or run-off.

10.47 Backfilling

Backfilling shall not be done until all required tests are performed and the District grants approval to backfill. The following are the requirements for backfilling:

- A. In sensitive areas such as at bends or in rocky terrain, pipe shall be surrounded with sand. Provide a 4-inch bed of sand and cover the pipe with 4 inches of sand followed by remaining backfill material to a depth mandated for each pipe type.
- B. Backfill in areas that are to be paved shall provide pipe with a 6-inch cover and a 4-inch bed of sand followed by remaining backfill material to a depth mandated for each pipe type.
- C. The remaining backfill is to be of approved excavated material consisting of earth, loam, sandy clay, and sand. The backfill shall not contain any large clods, stones, or debris.
- D. The backfill shall be mechanically compacted to a dry density equal to that of the surrounding undisturbed soil.
- E. The backfill shall conform to the adjacent grades, without having any dips, humps, sunken areas, or other surface irregularities. The final grade shall be as specified on the Approved Landscape Plans.

10.48 Site Cleanup

- A. The site shall be maintained in a clean condition as work progresses. Refuse and excess dirt shall be removed from the site and disposed of properly at the Contractor's expense. All walks and other paved surfaces shall be swept and/or washed. The site shall be inspected for any damage caused either directly or indirectly by the Contractor. Any damage shall be restored to original condition.
- B. After the installation of the landscape irrigation system and at other times as directed by the District, the Contractor shall remove all trash, debris, surplus material, and unneeded equipment from the site. The site shall be maintained in an orderly fashion at all times.

SECTION 11 - PLANT SELECTION AND PLACEMENT

11.01 General Planting Concepts

- A. All planting plans shall comply with applicable codes including AB 1881: the Model Water Efficient Landscape Ordinance.
- B. Landscape design shall complement overall streetscape design, adjacent uses and landscaping.
- C. A minimum of one 15 gallon tree shall be provided for every 30 lineal feet of park/street frontage and in parking lot islands and edges. Trees shall be selected from the District tree list or shall be approved in writing by the District. Refer to SECTION 12 - PLANT LIST & USE STANDARDS.
- D. Plant materials shall be selected so that they properly fit the allotted space and do not cause damage to surrounding pavement, or other improvements. Design shall protect pavement from heaving upon tree maturation.
- E. Parking, loading and service areas, utilities, solid building surfaces, soundwalls, and fences shall be screened with landscaping. However, clinging plant materials such as vines, should not be placed in areas that will result in attachment to structures located outside of the District's right-of-way. Vines on soundwalls are preferred.
- F. Parking areas shall be screened from streets with low shrubs, walls, and/or earth-berms at a 30-inch maximum height.
- G. No shrubs shall be greater than 4 feet tall unless approved by District.
- H. Landscape plants shall be selected from the District Approved Preferred Plant List or be otherwise approved by the District. These plants shall be low maintenance, drought tolerant or appropriate native species, and shall require little or no routine pruning. The District encourages plants that display variations in texture and form, with attention to flowering shrubs and seasonal color.
- I. Plants shall be grouped by water requirements into hydro-zones.
- J. Turf shall not be installed in areas less than 6 feet in width.
- K. Turf shall not be installed on slopes exceeding 5:1, or within 10 feet of existing Oak tree driplines.
- L. Tree wells within hardscape must be a minimum of six feet in diameter or square.

- M. Trees planted in natural areas shall be drought tolerant or appropriate native species.
- N. Appropriate native hydroseed/seed drilling mix and native trees and shrubs shall be used on areas adjacent to open space, preserves, and waterways or drainage channels.
- O. Do not use landscape fabric in planter areas.

11.02 Turf

- A. Where turf is proposed, Tall Fescue or other Approved drought-tolerant variety shall be specified.
- B. Turf shall not be proposed on slopes exceeding 5:1, or within 10 feet of existing oak tree drip lines.
- C. Turf shall not be proposed in areas narrower than 6 feet wide. The square footage of turf shall be great enough to make turf maintenance cost effective.
- D. Where mowed-turf abuts fencing, structures, walls, decomposed granite pathways and/or grass areas requiring less or no mowing, a concrete mow band shall be provided to facilitate maintenance and shall be used at the base of fences and utility equipment in turf areas.
- E. Turf shall only be used in areas where turf maintains a valuable recreational resource and should not be used as general landscape area ground surfacing.
- F. Turf is limited for use on no more than 2/3 of the available usable open space within any park site.
- G. One fourth of the turf area should utilize varieties of turf-grass that require less or no mowing per year than standard varieties.

11.03 Planting near Utilities

- A. The following are minimum setbacks that shall be adhered to in the planting of trees. All utility lines, vaults, overhead lines, and streetlights shall be indicated on the Landscape Plans to avoid conflicts.
 - 1. Fire Hydrants: 10 feet
 - 2. Driveways (top of wing): 10 feet
 - 3. Stop Signs or Curb Returns: 15 feet
 - 4. Electroliers: 15 feet
 - 5. Storm Drain, Sanitary Sewer, Gas Lines: 10 feet

6. Water, Telephone, Electrical Main: 10 feet
 7. Streetlights: 10 feet
 8. Mail Boxes: 5 feet
 9. Power Lines: 15 feet
- B. Above ground utilities and backflow prevention devices shall be lightly-screened with landscaping.
 - C. Grading in the right-of-way shall accommodate proposed and existing utility vaults. In cases where walls around vaults are unavoidable, walls shall be masonry, concrete, or other permanent material.
 - D. Plant materials shall be selected so that they properly fit the allotted space and do not cause damage to underground utilities or other improvements.
 - E. Plant materials that require regular pruning or shaping (weekly and/or monthly) shall not be used in any District maintained area.
 - F. Utilities trench shall not impact existing vegetation to be retained. Tree protection plans illustrating existing vegetation shall be provided where applicable.
 - G. Trees shall be located a minimum of 20 feet from utility light poles.

11.04 Traffic Safety

- A. Plants shall preserve sight distance at site entries and exits and internal circulation routes. Design of plant material within intersection view sheds must comply with all local codes.
- B. Landscaping shall not obstruct building or parking lot light fixtures, address signs, street signs, building entrances, and windows.
- C. All trees located less than 5 feet from the curb, sidewalk or buildings shall have a root barrier. Root barrier does not wrap around root ball but is installed along length of paving.

11.05 Water Conservation

- A. The Estimated Landscape Water Use (ELWU) shall not exceed the Landscape Water Allowance (LWA).
- B. Plant materials shall be grouped into appropriate hydrozones per estimated landscape water use.

- C. Emphasis shall be placed on plants well suited to the microclimate and soil conditions at the given site and that require minimal water once established, are relatively free from pests and diseases, and are generally easy to maintain. Reference shall be made to Section 12 - PLANT LIST & USE GUIDE for recommended plant selections and grouping of like plant materials.
- D. The Landscape Architect shall refer to the Sacramento County water ordinances and AB 1881 for additional requirements.

SECTION 12: PLANT LIST & USE GUIDE

12.00 Invasive Species

The planting of invasive species is prohibited anywhere in the Cordova Recreation & Park District. An invasive species is defined by the California Invasive Plant Council as a plant that “disrupts ecosystems by altering physical processes, displaces native plants, and degrades wildlife habitat”. A full list of invasive species prohibited for use within the District can be found at: www.cal-ipc.org.

12.01 Approved Plant List

The provided plant material list(s) in this section are the approved plants for use within the Cordova Recreation and Park District. Plant species listed are exact species and the Developer/Contractor may not specify or utilize alternative plant material without written approval from the District. Any requests from the Developer/Contractor to use alternative plant material must be made in writing with use of appropriate form and submitted to the District for approval.

12.02 Planting Zones

The Cordova Recreation and Park District is located within region (2) two as stated by the University of California Cooperative Extension, Water Use Classification of Landscape Species Guide.

Local Region: Region (2) Two

Central Valley (California Climate Zones 8, 9 and 14), (CIMIS ETo Zones 12, 14, 15, and 16)

12.03 Area Type (AT)

The list below identifies zones to ensure ‘Best Management Practices’ when developing a landscape planting plan. The area types listed below correspond to the following plant list charts. Review the charts and labeling, similar plants shall be grouped and placed in appropriate areas to ensure the greatest possible success of the plant material.

TYPE 1: Turf Area Planting:

TYPE 2: Non-Turf Area Planting:

TYPE 3: Accent / Specimen Planting Area:

TYPE 4: Wet / Storm-water Basin Planting Area:

TYPE 5: Adjacent to Streetscape Planting Area:

TYPE 6: Ecological Restoration / Natural Area Planting Area:

12.04 Water Use Area (WA)

The list below identifies water use areas to insure 'Best Management Practices' when developing a landscape planting plan. The water use areas listed below correspond to the plant pallet chart. Plants with 'like' water requirements shall be grouped and placed in similar water use area.

Zone H: High Water Use:

A landscape planting area designed where *applied water* is provided once-a week or more, commonly in or adjacent to turf areas and/or near aquatic features where overspray/splash will occur.

Zone M: Moderate Water Use:

A landscape planting area designed where *applied water* is provided two-three times per month during the warm seasons.

Zone L: Low Water Use:

A landscape planting area designed where little *applied water* is required.

Zone VL: Very Low Water Use:

A landscape planting area designed where minimal to no *applied water* will be provided, commonly referred to as *xeriscaping*.

Zone B: Variable Water Use / Street-side or Area Bioswale:

Typically refers to a Bioswale area where *applied water* is infrequent but heavy at times. Plants in this zone can accommodate periods of extended drought and periods of heavy precipitation provided by irrigation and/or street runoff. In most cases plantings in this zone will be exposed to excessive soil pollutants. Plants selected must be compatible to these types of conditions.

Zone R: Temporary Supplemented Water Use:

A landscape planting area that would require no more than (3) years of *applied water* or a landscape planting area designed to have irrigation systems shut-off and/or removed after (3) years of use.

12.05 Key Legend

The list below corresponds to the following plant list charts. Review the charts and labeling, like plants shall be grouped and placed in appropriate Area Type (AT) and Water Use Areas (WA) to insure the greatest possible success of the plant material.

Plant Type (PT):

- T** Tree
- S** Shrub
- V** Vine
- Gc** Groundcover
- Tf** Turf
- P** Perennial (includes: ferns, grasses, sedges and bulbs)
- Bi** Biennial

Other Characteristics (O):

- E** Evergreen Species
- D** Deciduous Species

Preferred Plants: Large Tree (T) List

Height and Spread 30' to 100'

Botanical Name	Common Name	(O)	(PT): Size	(WA)	(AT)	Soil Type
Acer macrophyllum	Big Leaf Maple	D	T: 75x50	H	1, 2, 4	Most Soils
Acer negundo	Box Elder	D	T: 50x50	M	1, 2, 6	Not Defined
Acer rubrum	Red Maple	D	T: 60x40	H	1, 2, 4, 5	Most Soils
Alnus rhombifolia	White Alder	D	T: 90x40	H, B	1, 2, 4	Most Soils
Arbutus unedo	Strawberry Tree	E	T: 35x35	L	2, 3	Most Soils
Calocedrus decurrens	Incense Cedar	E	T: 75x20	M	1, 2	Most Soils
Carpinus betulus 'Fastigiata'	European Hornbeam	D	T: 40x35	M	1, 2, 5	Most Soils
Cedrus deodara	Deodar Cedar	E	T: 80x40	M	2, 4	Well Drained
Cercidium fkididum	Blue Palo Verde	D	T: 35x30	L	2	Good Drainage
Fagus sylvatica	European Beech	D	T: 85x55	H	1, 2, 5	Good Drainage
Ginkgo biloba	Maiden Hair Tree	D	T: 80x50	M	1, 2, 3, 5	Well Drained
Liriodendron tulipifera	Tulip Tree	D	T: 80x40	H	1, 2, 4	Well Drained
Metasequoia glyptostroboides	Dawn Redwood	D	T: 90x20	H	1, 2, 3	Well Drained
Nyssa sylvatica	Tupelo Tree	D	T: 50x25	M, B	1, 2, 4, 5	Most Soils

Phoenix canariensis	Canary Island Date Palm	E	T: 60x50	L	1, 2, 3	Most Soils
Pistacia chinensis	Chinese Pistache	D	T: 60x50	L	1, 2, 5	Good Drainage
Plantanus acerfolia	London Plane Tree	D	T: 80x40	M	1, 2, 4, 5	Most Soils
Plantanus racemosa	California Sycamore	D	T: 80x50	M	1, 2, 4, 5	Most Soils
Populus fremontii	Western Cottonwood	D	T: 60x30	M	6	
Quercus agrifolia	Coast Live Oak	D	T: 65x75	VL, R	2, 6	Good Drainage
Quercus douglasii	Blue Oak	D	T: 50x70	VL, R	2, 6	Good Drainage
Quercus kelloggii	Black Oak	D	T: 80x80	M	2, 6	Good Drainage
Quercus lobata	Valley Oak	D	T: 80x80	L, R	1, 2, 6	Good Drainage
Quercus palustris	Pine Oak	D	T: 80x40	M	1, 2, 4	Most Soils
Quercus rubra	Red Oak	D	T: 75x50	M	2	Good Drainage
Quercus wislizenii	Interior Live Oak	E	T: 75x85	VL, R	2, 6	Good Drainage
Sequoia sempervirens 'Aptos Blue'	Aptos Blue Coast Redwood	E	T: 90x30	H	1, 2, 4	Well Drained
Sequoiadendron giganteum	Giant Sequoia	E	T: 100x50	M	1, 2, 4	Well Drained
Taxodium distichum	Bald Cypress	D	T: 70x30	M	1, 2, 4	Most Soils
Tilia cordata cvs.	Little Leaf Linden	D	T: 50x25	M	1, 2, 5	Most Soils
Ulmus 'Frontier'	Frontier Elm	D	T: 40x30	M	1, 2	Most Soils
Ulmus parvifolia	Chinese Elm	D	T: 60x70	M	1, 2	Most Soils
Zelkova serrata	Saw Leaf Zelkova	D	T: 60x60	M	1, 2, 5	Most Soils

Preferred Plants: Medium Tree (T) List

Height and Spread 15' to 30'

Botanical Name	Common Name	(O)	(PT): Size	(WA)	(AT)	Soil Type
Acer buergeranum	Trident Maple	D	T: 25x25	M	1, 2	Most Soils
Aesculus californica	California Buckeye	D	T: 25x25	L, R	2, 6	Most Soils
Cercis canadensis	'Oklahoma' Redbud	D	T: 30x30	M	1, 2, 3	Good Drainage
Cercis occidentalis	Western Redbud	D	T: 15x15	L, R	2, 6, 3	Good Drainage
Chamaerops humilis	Mediterranean Fan Palm	E	T: 20x20	L	2, 3	Most Soils
Chionanthus retusus	Chinese Fridge Tree	D	T: 20x15	M	2, 3	Good Drainage
Cornus kousa	Kousa Dogwood	D	T: 20x20	H	2, 3	Most Soils

DESIGN & CONSTRUCTION STANDARDS MANUAL: June 2015

Cornus x 'Rutgan Aurora'	Aurora White Dogwood	D	T: 20x20	H	2, 3	Most Soils
Cornus x 'Rutgan Stellar Pink'	Stellar Pink Dogwood	D	T: 20x20	H	2, 3	Most Soils
Faijooa sellowiana	Pineapple Guava	E	T: 20x20	M	2, 3	Not Defined
Heteromeles arbutifolia	Toyon	E	T: 20x15	VL, R	2, 6	Most Soils
Lagerstroemia sp.	Crape Myrtle	D	T: Vary	M	1, 2, 3, 5	Good Drainage
Magnolia soulangiana	Saucer Magnolia	D	T: 25x30	M	2, 3	Most Soils
Malus floribunda	Japanese Flowering Crabapple	D	T: 25x20	M	2, 3	Most Soils
Olea europaea 'Monher'	'Majestic Beauty' Fruitless Olive	E	T: 30x25	VL	2, 3	Most Soils
Rhus lancea	African Sumac	E	T: 25x30	M	2	Good Drainage
Salix exigua	Sandbar Willow	D	T:	H	6	Good Drainage
Salix gooddingii	Gooding's Willow	D	T:	H	6	Good Drainage
Salix laevigata	Red Willow	D	T:	H	6	Good Drainage
Salix lasiolepis	Arroyo Willow	D	T:	H	6	Good Drainage
Styrax japonicus	Japanese Snowdrop Tree	D	S: 30x20	L	2, 3	Well Drained
Trachycarpus fortunei	Windmill Fan Palm	E	T: 30x10	M	2	Most Soils

Preferred Plants: Small Tree (T) List

Height and Spread 10' to 20'

Botanical Name	Common Name	(O)	(PT): Size	(WA)	(AT)	Soil Type
Corylus 'Contorta'	Harry Lauder's Walking Stick	D	S: 10x10	M	2, 3	Most Soils
Fremontodendron	Flannel Bush	E	T: 15x12	L	2, 6	Good Drainage
Heteromeles arbutifolia	Toyon	E	T: 15x15	L	2, 6	Most Soils
Hibiscus syriacus 'Aphrodite'	Aphrodite Rose of Sharon	D	S: 12x6	M	2	Most Soils
Hibiscus syriacus 'Collie Mullens'	Collie Mullens Rose of Sharon	D	S: 12x6	M	2	Most Soils
Hibiscus syriacus 'Diana'	Diana Rose of Sharron	D	S: 12x6	M	2	Most Soils
Lagerstroemia indica	Crepe Myrtle	D	T: Vary	M	2, 3, 5	Good Drainage
Leptospermum	Australian Tea	E	S: 15x15	L	2	Good Drainage

laevigatum	Tree					
Leptospermum scoparium 'Burgundy Queen'	Burgundy Queen New Zealand Tea Tree	E	S: 12x10	M	2	Good Drainage
Lindera obtusiloba	Japanese Spicebush	D	T: 15x15	M	2	Good Drainage
Magnolia stellata	Star Magnolia	D	T: 10x20	M	2, 3	Most Soils

Preferred Plants: Shrub/Perennial (S, P) List

Height and Spread Vary by Species

Botanical Name	Common Name	(O)	(PT): Size	(WA)	(AT)	Soil Type
Rosa x 'Noatraum'	Pink Flower Carpet Rose	E	S: 2x3	M	2, 5	Good Drainage
Rosa x 'Noare'	Red Flower Carpet Rose	E	S: 2x3	M	2, 5	Good Drainage
Rosa x 'Noaschnee'	White Flower Carpet Rose	E	S: 2x3	M	2, 5	Good Drainage
Aloe vera	Medicinal Aloe	E	P: 1.5x4	L	2	Most Soils
Alyogyne huegelii	Blue Hibiscus	D	S: 7x7	L	2, 3	Most Soils
Artemisia douglasiana	Douglas Mugwort	E	P: 3xSPD	L, R	2, 6	Good Drainage
Baccharis pilularis	Dwarf Coyote Bush	E	P: 2x6	L	2	Most Soils
Ballota pseudodictamus	False Dittany	E	P: 1.5x2	VL	2	Good Drainage
Berberis thunbergii 'Aurea'	'Aurea' Barberry	D	S: 2.5x3	L	2, 5	Most Soils
Berberis thunbergii 'Crimson Pygmy'	'Crimson Pygmy' Barberry	D	S: 1.5x2.5	L	2, 5	Most Soils
Calamagostis x acutiflora 'Karl Foerster'	Karl Foerster Feather Reed Grass	D	P: 2x2	M	2, 5	Most Soils
Callistemon viminalis 'Little Johns'	Little Johns' Bottle Brush	E	P: 3x3	L	2, 5	Most Soils
Camellia sasanqua 'Chansonette'	Chansonette Camellia	E	S: 3x8	M	2	Good Drainage
Carex albula 'Frosty Curls'	'Fosty Curls' Sedge	E	P: 2x2	M	2, 5	Most Soils
Carex buchananii	'Fox Red' Leather Leaf Sedge	E	P: 3x2.5	M	2, 5	Most Soils
Carex divulsa	Berkeley Sedge	E	P: 1.5x2	M	2, 5	Most Soils
Carex elata 'Bowles'	'Bowles Golden'	E	P: 2.5x1.5	M	2, 5	Most Soils

DESIGN & CONSTRUCTION STANDARDS MANUAL: June 2015

Golden'	Sedge					
Carex morrowii 'Aurea Varigata'	Varigated Japanese Sedge	E	P: 1x1.5	M	2, 5	Most Soils
Ceanothus gloriosus 'Yankee Point'	'Yankee Point' Ceanothus	E	S: 3x10	L	2	Well Drained
Ceanothus maritimus	Maritime Ceanothus	E	S: 3x8	L	2	Well Drained
Cistus x pulverulentus 'Sunset'	'Sunset' Rock Rose	E	S: 2x7	L	2	Good Drainage
Coleonema pulchellum 'Sunset Gold'	'Sunset Gold' Pink Breath of Heaven	E	S: 1.5x4	M	2, 5	Fast Drainage
Cornus stolonifera 'Insanti Compact'	'Insanti' Compact Redtwig Dogwood	D	5x5	M	2, 3, 4	Not Defined
Cotoneaster apiculatus	Cranberry Cotoneaster	D	S: 3x6	L	2, 5	Most Soils
Cotoneaster dammeri 'Eichholz'	'Eichholz' Bearberry Cotoneaster	E	S: 1x6	L	2, 5	Most Soils
Cotoneaster horizontalis	Rock Cotoneaster	D	S: 3x15	L	2	Most Soils
Deschampsia c. 'Susan's Choice'	Tufted Hairgrass			L	2	
Dianella revolute 'Little Becca'	Little Becca Blue Lily Flax	E	P: 2x2	M	2, 5	Good Drainage
Dianella revolute 'Little Rev'	Little Rev Blue Lily Flax	E	P: 2x2	M	2, 5	Good Drainage
Diets bicolor	Fortnight Lily	E	P: 3x3	L	2, 5	Most Soils
Echeveria x imbricata	Hens and Chicks	E	P: .5x1	L	2	Most Soils
Echinacea purpurea	Purple Cone Flower	D	P: .5x2	M	2	Most Soils
Eriogonum umbellatum	Sulfer Flower	E	P: 2x4	L	2	Well Drained
Euonymus alatus 'Little Moses'	'Little Moses' Burning Bush	D	S: 3x3	M	2, 5	Most Soils
Euonymus fortunei 'Canadale Gold'	Canadale Gold Wintercreeper	E	S: 4x3	M	2	Most Soils
Festuca californica	California Fescue	E	P: 2x2	M	2, 6	Good Drainage
Festuca glauca	Common Blue Fescue	E	P: 1x1	L, R	2	Good Drainage
Festuca i. 'Siskiyou	Blue Idaho	E	P: 1x1	L, R	2	Good Drainage

DESIGN & CONSTRUCTION STANDARDS MANUAL: June 2015

Blue'	Fescue					
Festuca idahoensis	Idaho Fescue	E	P: 1x1	L, R	2, 6	Good Drainage
Genista Lydia	Prostrate Genista	D	P: 2x5	L	2	Good Drainage
Helictotrichon sempervirens	Blue Oat Grass	D	P: 3x3	L	2, 5	Well Drained
Hesperaloe parvifolia	Red Yucca	E	P: 3x3	L	2	Most Soils
Heuchera cv.	Coral Bells	E	P: 1.5x1.5	M	2	Well Drained
Hydrangea macrophylla 'Pia'	Pink Elf French Hydrangea	D	S: 1.5x2	H	2	Most Soils
Hydrangea quercifolia 'Snow Queen'	Snow Queen Oakleaf Hydrangea	D	S: 4x6	H	2	Most Soils
Hydrangea quercifolia 'Vaughn's Lillie'	Vaughn's Lillie Oakleaf Hydrangea	D	S: 4x5	H	2	Most Soils
Iberis sempervirens	Evergreen Candytuft	E	P: 1x1	M	2	Well Drained
Juncus effusus	Rush	D	P: 2x2	H, B	2, 4, 6	Most Soils
Juncus patens	Gray Rush	D	P: 2x2	H, B	2, 4, 6	Most Soils
Kniphofia uvaria 'Flamenco'	'Flamenco' Red Hot Poker	E	P: 2x3	M	2	Most Soils
Lavandula angustifolia 'Hidcote'	'Hidcote' English Lavender	E	P: 2x2	L	2, 5	Well Drained
Lavandula dentata 'Goodwin Creek'	'Goodwin Creek' English Lavender	E	P: 3x4	L	2, 5	Well Drained
Lavandula x intermedia 'Grosso'	'Grosso' Hedge Lavender	E	P: 2.5x2.5	L	2, 5	Well Drained
Liriope mauscaris	Big Blue Lilyturf	E	P: 1.5x2	M	2, 5	Good Drainage
Loropetalum chinense 'Suzanne'	'Suzanne' Fringe Flower	E	S: 3x3	M	2, 5	Well Drained
Lotus scoparis	Deerweed	E	P: 2x2	VL	2	Well Drained
Mimulus aurantiacus	Yellow Sticky Monkey Flower		P: 4.5x5	L	2	Well Drained
Miscanthus sinensis 'Little Kitten'	Little Kitten Miden Grass	D	P: 1.5x2	H	2	Most Soils
Mohonia aquifolium 'compacta'	Dwarf Oregon Grape	E	S: 3x5	M	2	Most Soils
Muhlenbergia capillaries	Pink Muhly Deer Grass	D	P: 3x3	H	2	Good Drainage
Muhlenbergia capillaries 'Lenca'	'Regal Mist' Pink Muhly Grass	D	P: 2x3	H	2	Good Drainage
Muhlenbergia lindheimeri 'Autumn Glow'	Autumn Glow Muhly Grass	D	P: 3x3	H	2	Good Drainage

DESIGN & CONSTRUCTION STANDARDS MANUAL: June 2015

Muhlenburgia rigens	Deer Grass	D	P: 3x3	L	2, 5	Good Drainage
Myrtus communis 'Compacta'	Dwarf Myrtle	E	S: 3x3	L	2	Good Drainage

Nandina domestica 'Filamentosa'	Threadleaf Nandina	E	S: 3x3	L	2	Most Soils
Nandina domestica 'Firepower'	'Firepower' Heavenly Bamboo	E	S: 2x2	L	2, 5	Most Soils
Nandina domestica 'Gulf Stream'	'Gulf Stream' Heavenly Bamboo	E	S: 3x1.5	L	2, 5	Most Soils
Osmanthus 'heterophyllus' 'Goshiki'	'Goshiki' False Holly-leaf Osmanthus	E	S: 3.5x5	M	2	Most Soils
Pennisetum alopecuroides	Fountain Grass	D	P: 3x3	L	2	Most Soils
Penstemon 'Red Riding Hood'	'Red Riding Hood' Foothill Penstemon	E	P: 3x3	M	2	Well Drained
Penstemon heterophyllus	Foothill Penstemon	E	P: 3x3	M	2	Well Drained
Phormium hybrids 'Apricot Queen'	'Apricot Queen' New Zealand Flax	E	P: 3x5	L	2	Most Soils
Phormium hybrids 'Platt's Black'	'Platt's Black' New Zealand Flax	E	P: 3x4	L	2, 5	Most Soils
Phormium hybrids 'Sundowner'	'Sundowner' New Zealand Flax	E	P: 5x5	L	2	Most Soils
Phormium tenax 'Jack's Spratt'	'Jacks Spratt' New Zealand Flax	E	P: 1.5x1.5	L	2, 5	Most Soils
Phormium tenax 'Rainbow Warrior'	'Rainbow Maiden' New Zealand Flax	E	P: 3x3	L	2	Most Soils
Pittosporum tobira 'Crème de Mint'	'Crème de Mint' Pittosporum	E	S: 2x2.5	M	2, 5	Most Soils
Pittosporum tobira 'Wheeler's Dwarf'	'Wheeler's Dwarf' Pittosporum	E	S: 3x5	M	2	Most Soils
Rhamnus californica 'Seaview'	'Seaview' Coffeeberry	E	S: 1.5x8	L	2	Most Soils
Rhaphiolepis indica	'Ballerina' Indian	E	S: 2x4	M	2, 5	Most Soils

'Ballerina'	Hawthorne					
Rosmarinus officinalis 'Roman Beauty'	'Roman Beauty' Rosemary	E	S: 3x2	L	2	Most Soils
Salvia spathacea	Hummingbird Sage	E	S: 2x4	M	2	Good Drainage
Salvia x sylvestris	Meadow Sage	E	S: 2x2	M	2	Good Drainage
Santolina chamaecyparissus	Lavender Cotton	E	P: 2x3	L	2	Well Drained
Saponaria ocymoides	Soapwort	E	P: 1x3	L	2	Most Soils
Sedum x 'Autumn Joy'	'Autumn Joy' Sedum	E	P: 2x2	L	2, 5	Most Soils
Solidago	Goldenrod	E	P: 2x2	M	2	Most Soils
Spiraea 'Goldflame'	'Goldflame' Spiraea	D	S: 2.5x2.5	M	2, 5	Most Soils
Spiraea 'Goldmound'	'Goldmound' Spirea	D	S: 3x4	M	2	Most Soils
Stipa gigantea	Giant Feather Grass	D	P: 3x3	L	2, 5	Most Soils
Teucrium f. 'Compactum'	Compact Blue Bush Germander	E	S: 3x3	L	2	Well Drained
Teucrium x lucidrys 'Nanum'	Dwarf Germander	E	P: 1x2	L	2	Well Drained
Tulbaghia violacea	Society Garlic	E	P: 1.5x1.5	M	2, 5	Well Drained
Tulbaghia violacea 'Silver Lace'	Silver Lace Society Garlic	E	P: 1.5x1.5	M	2, 5	Well Drained
Zauschneria californica	California Fuchsia	E	P: 3x3	L	2	Most Soils

Preferred Plants: Vine(V) List

Height and Spread Vary by Species

Botanical Name	Common Name	(O)	(PT): Size	(WA)	(AT)	Soil Type
Parthenocissus quinquefolia	Virginia Creeper	D	V: 40x40	M	2, 5	Most Soils
Ficus pumila	Creeping Fig	E	V: 25x30	M	2, 5	Most Soils
Hardenbergia violacea	Lilac Vine	E	V: 10x10	M	2	Well Drained
Jasminum polyanthum	Pink Jasmine	E	V: 20x20	M	2	Most Soils
Parthenocissus tricuspidata	Boston Ivy	D	V: 30x30	M	2, 5	Most Soils
Solanum laxum	Potato Vine	E	V: 30x30	M	2	Most Soils

Preferred Plants: Groundcover (Gc) LIST

Height and Spread Vary by Species

Botanical Name	Common Name	(O)	(PT): Size	(WA)	(AT)	Soil Type
Arctostaphylos u. 'Green Supreme'	'Green Supreme' Bearberry Manzanita	E	Gc:.5x10	L	2, 5	Most Soils
Arctostaphylos u. 'Wood's Compact'	'Wood's Compact' Bearberry Manzanita	E	Gc: .5x10	L	2, 5	Most Soils
Arctostaphylosu. 'Point Reyes'	'Point Reyes' Bearberry Manzanita	E	Gc: .5x10	L	2, 5	Most Soils
Cerastium tomentosum	Snow in Summer	E	Gc: .8x3	M	2, 5	Good Drainage
Cercocarpus betuloides var. blancheae	Island Mountain Mohongany	E	Gc: .8x3	VL	2, 5	Good Drainage
Myoporum parvifolium	Myoporum	E	Gc: .5x9	M	2, 5	Most Soils

Preferred Plants: Turf (Tf) List

GENERAL PARK USE

Plush Fescue Blend (or approved equal): Full sun or partial shade.

35% Success tall fescue

35% Chapel Hill tall fescue

35% Pedestal tall fescue

Minimum Purity 98% Maximum Crop 0.50% and Weed 0.05% Minimum Germination 85%

Seed: 10-12 pounds/1,000 square feet.

Emergence: 8-21 days

Establishment: 50 days

Fine Leaf Park Mix (or approved equal): Shade tolerant.

25% Pearl Perennial Ryegrass

25% Quest Perennial Ryegrass

25% Creeping Red Fescue

15% Kenblue Kentucky Bluegrass

10% Baron Kentucky Bluegrass

Minimum Purity 98% Maximum Crop 0.50% and Weed 0.05% Minimum Germination 85%

Seed: 6-8 pounds/1,000 square feet.

Emergence: 8-14 days

Establishment: 50 day

ATHLETIC FIELDS

80/20 Turf Mix (or approved equal): Full sun to light shade

80% Turf-type Tall Fescue

20% Kentucky Bluegrass

Minimum Purity 98% Maximum Crop 0.50% and Weed 0.05% Minimum Germination 85%

Seed: 8-10 pounds/1,000 square feet.

Emergence: 14-21 days

Establishment: 70 days

CALIFORNIA NATIVE LAWN SUBSTITUTE

Native Perennial Turf (or approved equal): Erosion and weed control, lawn substitute

90 % Molate Red Fescue

5 % San Diego Bent grass

5% Achellea millefolium

Note: Once established, low maintenance and no-irrigation required. Mow once or twice a year. Provides minimal color in the summer when grasses go dormant. The plants are active with winter rains. Plant before the first rains into a finely worked seedbed - may require supplemental irrigation and weed control during the first year to aid establishment.

Cordova Recreation & Park District

Construction Details

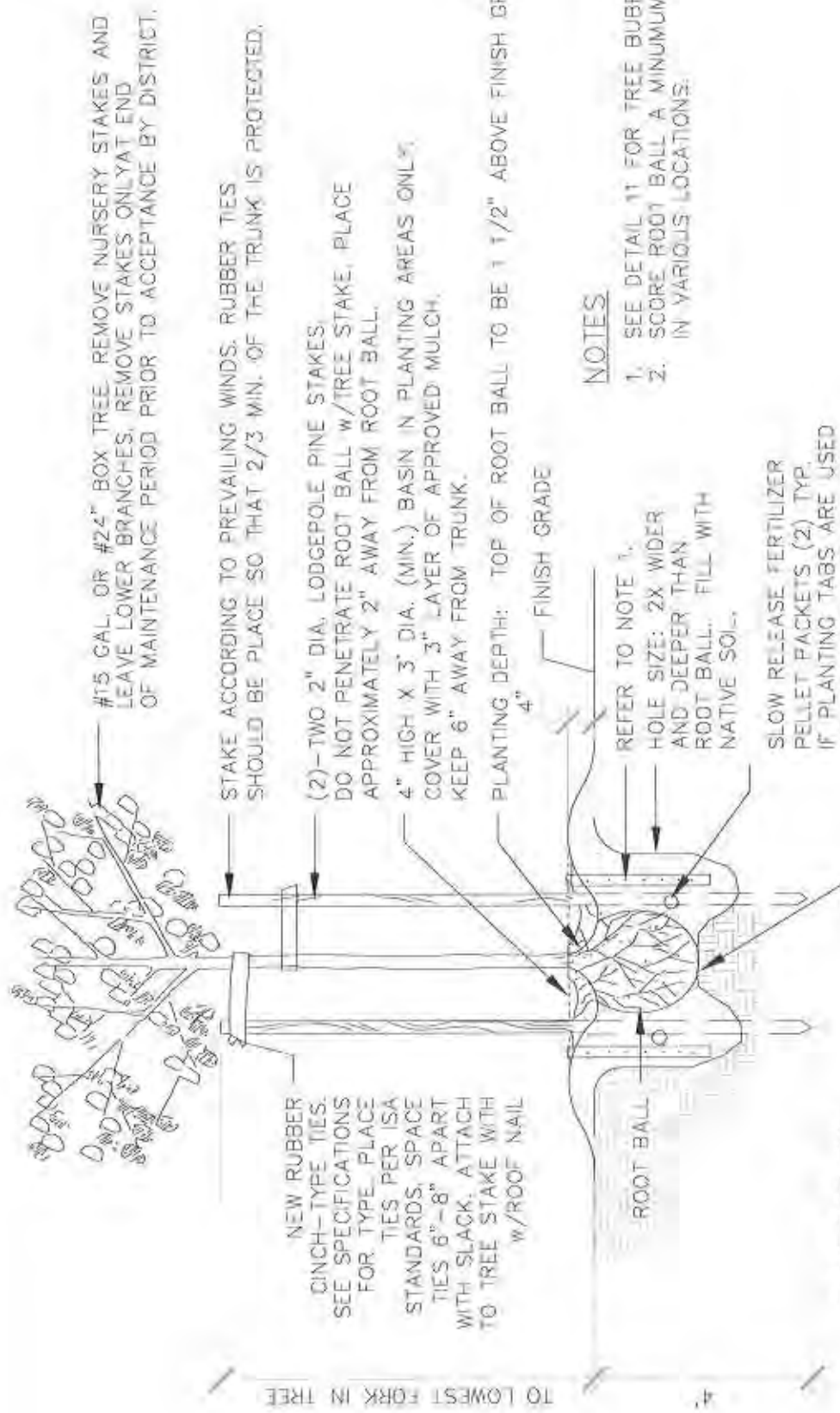

#15 GAL. OR #24" BOX TREE. REMOVE NURSERY STAKES AND LEAVE LOWER BRANCHES. REMOVE STAKES ONLY AT END OF MAINTENANCE PERIOD PRIOR TO ACCEPTANCE BY DISTRICT.

STAKE ACCORDING TO PREVAILING WINDS. RUBBER TIES SHOULD BE PLACED SO THAT 2/3 MIN. OF THE TRUNK IS PROTECTED.

(2) - TWO 2" DIA. LODGEPOLE PINE STAKES. DO NOT PENETRATE ROOT BALL W/TREE STAKE. PLACE APPROXIMATELY 2" AWAY FROM ROOT BALL.

4" HIGH X 3" DIA. (MIN.) BASIN IN PLANTING AREAS ONLY. COVER WITH 3" LAYER OF APPROVED MULCH. KEEP 6" AWAY FROM TRUNK.

PLANTING DEPTH: TOP OF ROOT BALL TO BE 1 1/2" ABOVE FINISH GRADE.

NOTES

1. SEE DETAIL 11 FOR TREE BUBBLER.
2. SCORE ROOT BALL A MINIMUM OF 4 TIMES IN VARIOUS LOCATIONS.

REFER TO NOTE 1.

HOLE SIZE: 2X WIDER AND DEEPER THAN ROOT BALL. FILL WITH NATIVE SOIL.

SLOW RELEASE FERTILIZER PELLET PACKETS (2) TYP. IF PLANTING TABS ARE USED (4) TABS MIN. FOR 15 GAL. (6) TABS MIN. FOR 24" BOX SPACED EVENLY AROUND ROOTBALL.

NEW RUBBER CINCH-TYPE TIES. SEE SPECIFICATIONS FOR TYPE. PLACE TIES PER ISA STANDARDS. SPACE TIES 6"-8" APART WITH SLACK. ATTACH TO TREE STAKE WITH W/ROOF NAIL

PLACE ROOT BALL ON UNDISTURBED NATIVE SOIL.



TREE PLANTING

CORDOVA RECREATION AND PARK DISTRICT

SCALE: NOT TO SCALE
REVISED: JULY 2014

#15 GAL. OR #24" BOX TREE, REMOVE NURSERY STAKES AND LEAVE LOWER BRANCHES. REMOVE STAKES ONLY AT END OF MAINTENANCE PERIOD PRIOR TO ACCEPTANCE BY DISTRICT, STAKE ACCORDING TO PREVAILING WIND.

(2) - TWO 2" DIA. LODGEPOLE PINE. DO NOT TOUCH ROOT BALL, PLACE APPROXIMATELY 2" AWAY FROM ROOT BALL.

4" HIGH X 3' DIA. (MIN.) BASIN IN PLANTING AREAS ONLY. COVER WITH 2" LAYER OF APPROVED MULCH. KEEP MULCH 6" AWAY FROM TRUNK.

PLANTING DEPTH: TOP OF ROOT BALL TO BE 1 1/2" ABOVE FINISH GRADE.

FINISH GRADE

EXISTING SLOPE TO BE 2:1 MAXIMUM. BLEND INTO EXISTING SLOPE.

REFER TO NOTE 1.

SLOW RELEASE FERTILIZER PELLET PACKETS (2) TYP. IF PLANTING TABS ARE USED (4) TABS MIN. FOR #15 GAL. (6) TABS MIN. FOR #24" BOX SPACED EVENLY AROUND ROOTBALL

NEW RUBBER CHINCH TYPE TIES. PLACE TIES PER ISA STANDARDS. PLACE 6"-8" APART WITH SLACK.

ROOT BALL
HOLE SIZE: (2)X WIDER THAN ROOT BALL. FILL WITH NATIVE SOIL.

EXCAVATED SOIL, FOOT TAMPED INTO PLACE PRIOR TO PLACING TREE IN BASIN.

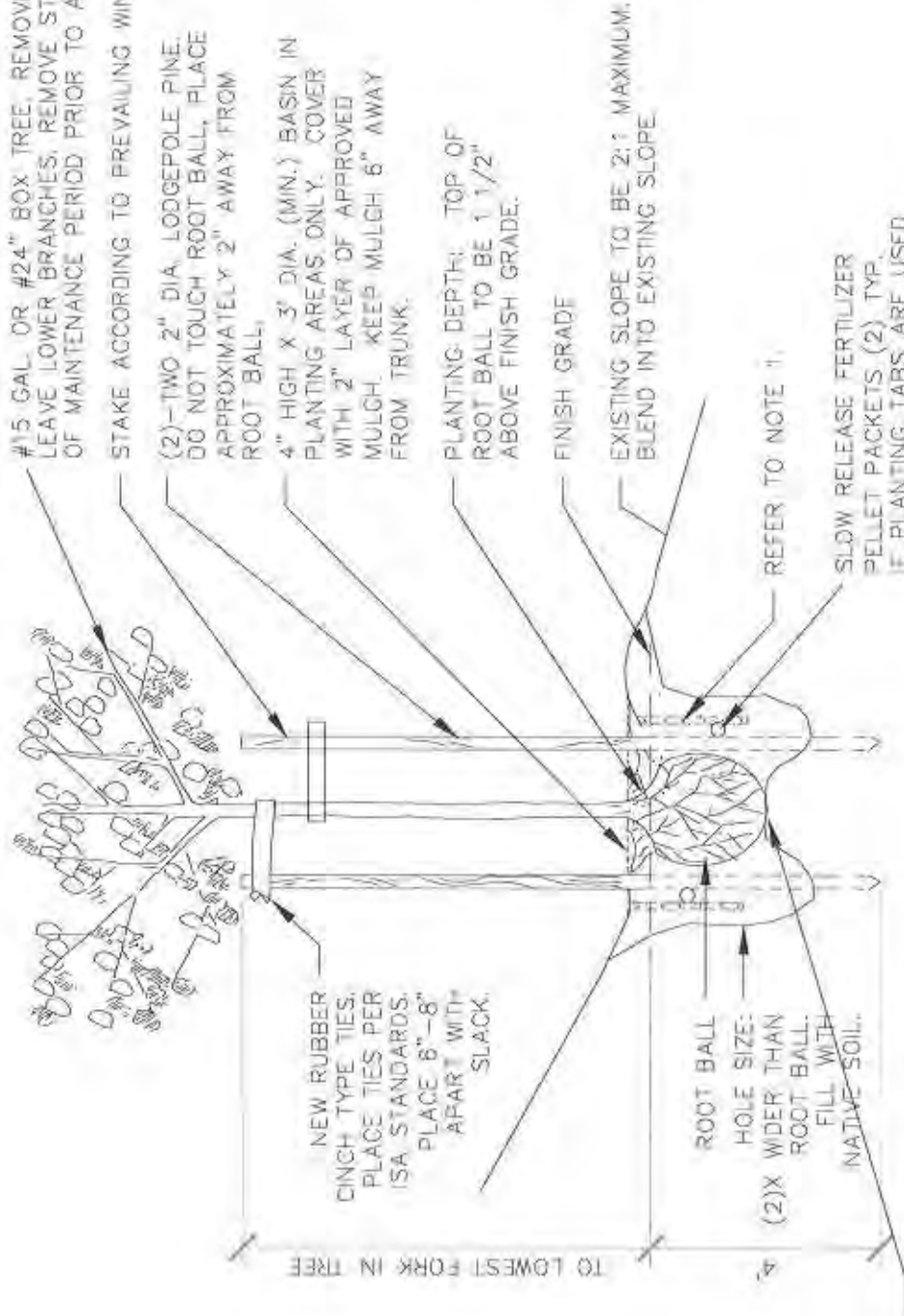

NOTES

1. SEE DETAIL #1 TREE BUBBLER.
2. SCORE ROOT BALL A MINIMUM OF 4 TIMES IN VARIOUS LOCATIONS.
3. BUBBLERS TO BE PLACED ON THE UPHILL SIDE OF TREE.

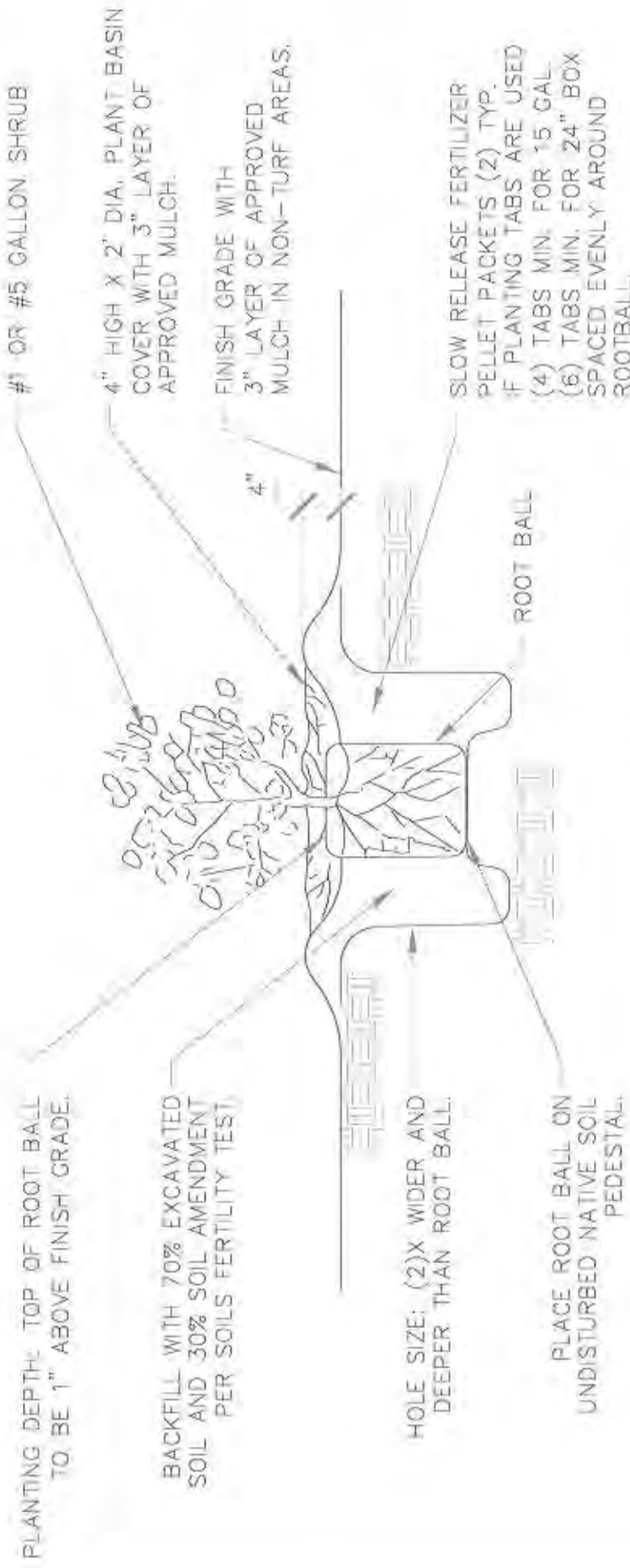

NOTES

1. AMENDMENT SHALL BE CONSISTENT WITH SOILS FERTILITY TEST.
2. PLANTING AREAS SHALL BE TREATED WITH PRE-EMERGENT AFTER PLANTING AND BEFORE MULCHING TO PREVENT GERMINATION OF WEED SEEDS.



SHRUB PLANTING

CORDOVA RECREATION AND PARK DISTRICT

SCALE: NOT TO SCALE
REVISED: JULY 2014

#1 OR #5 GALLON SHRUB

PLANTING DEPTH: TOP OF ROOT BALL TO BE 1" ABOVE FINISH GRADE.

4" HIGH X 2' DIA. PLANT BASIN COVER WITH 3" LAYER OF APPROVED MULCH.

FINISH GRADE

PLACE ROOT BALL ON PEDESTAL OF NATIVE SOIL. BACKFILL WITH 70% EXCAVATED SOIL AND 30% SOIL AMENDMENT PER SOILS FERTILITY TEST.

EXISTING SLOPE TO BE 2:1 MAXIMUM. BLEND INTO EXISTING SLOPE.

ROOT BALL

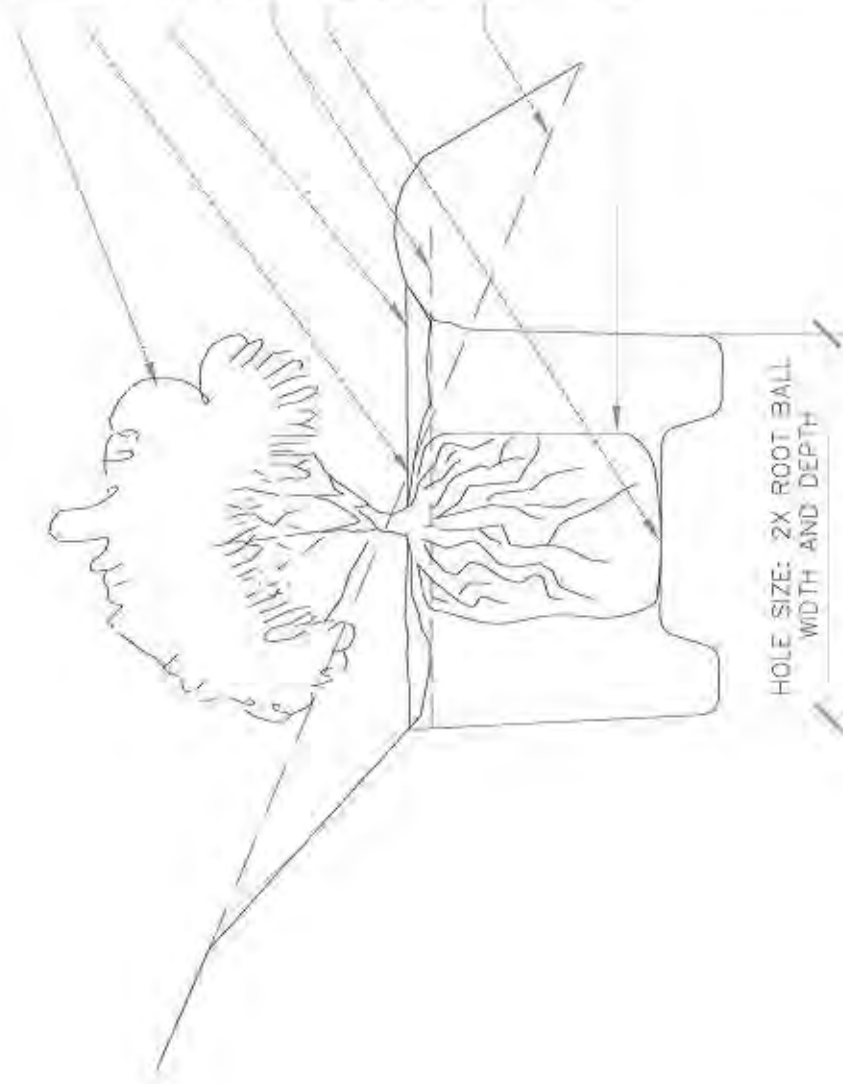

HOLE SIZE: 2X ROOT BALL WIDTH AND DEPTH

NOTES

1. PLANTER AREAS SHALL HAVE PRE-EMERGENT HERBICIDE APPLIED BEFORE PLANTING TO PREVENT GERMINATION OF WEED SEEDS.
2. BUBBLERS TO BE PLACED ON UPHILL SIDE OF SHRUB.

SECTION

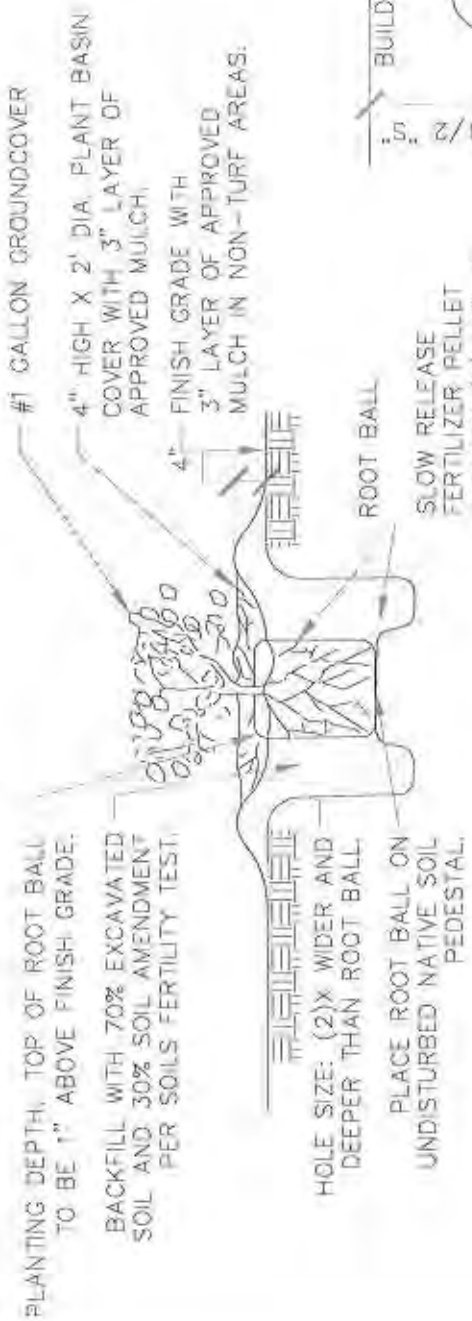

PLAN

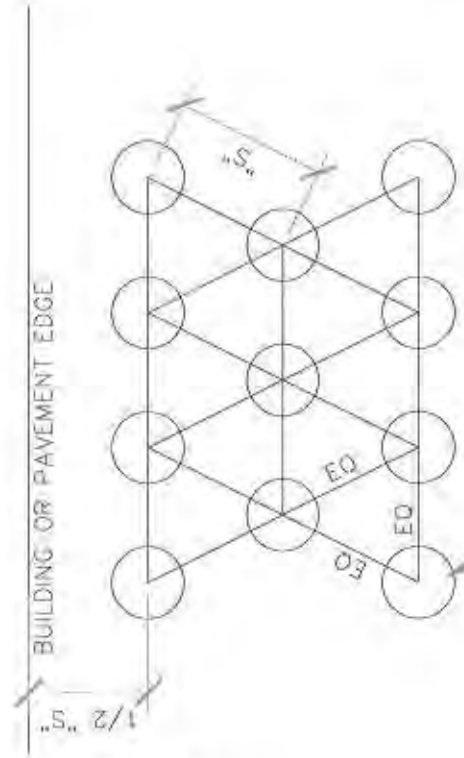

NOTES

1. "S" REFERS TO PLANT SPACING, SEE PLANT TABLE ON CONSTRUCTION DOCUMENTS.

NOTES

1. AMENDMENT SHALL BE CONSISTENT WITH SOILS FERTILITY TEST.
2. PLANTING AREAS SHALL BE TREATED WITH PRE-EMERGENT AFTER PLANTING AND BEFORE MULCHING TO PREVENT GERMINATION OF WEED SEEDS.

SLOW RELEASE FERTILIZER PELLET PACKETS (2) TYP. IF PLANTING TABS ARE USED (4) TABS MIN. FOR 15 GAL. (6) TABS MIN. FOR 24" BOX SPACED EVENLY AROUND ROOTBALL.



GROUNDCOVER PLANTING

CORDOVA RECREATION AND PARK DISTRICT

SCALE: NOT TO SCALE
REVISED: JULY 2014

PRESSURE MAIN LINE

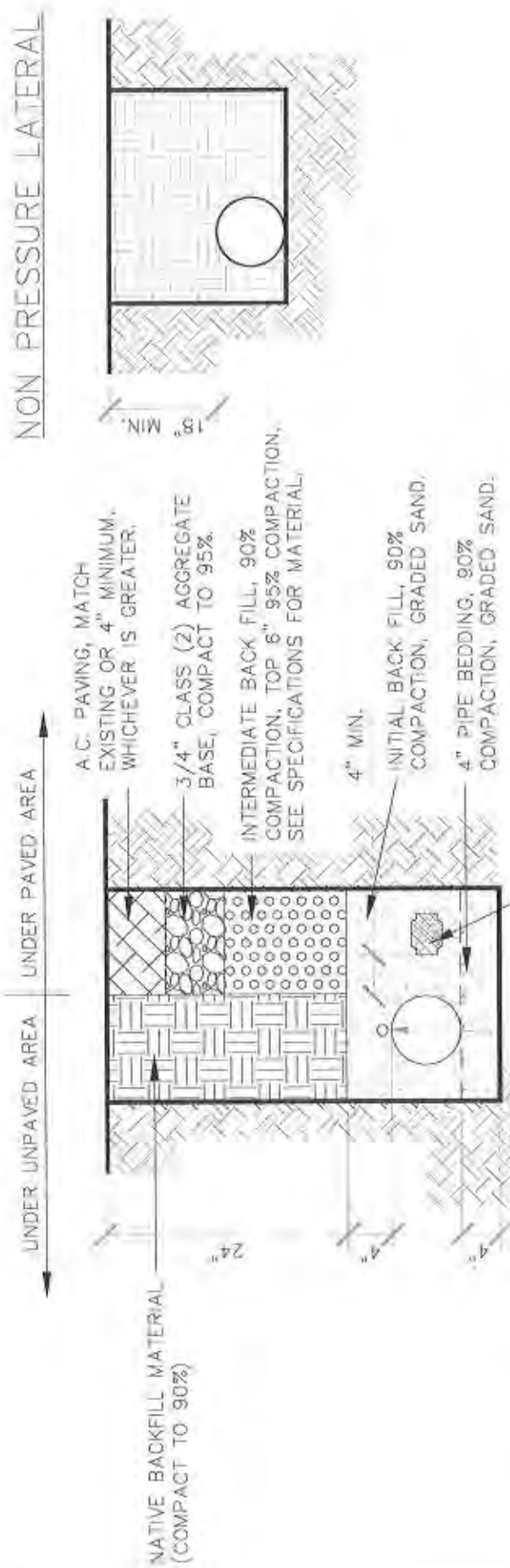

NON PRESSURE LATERAL

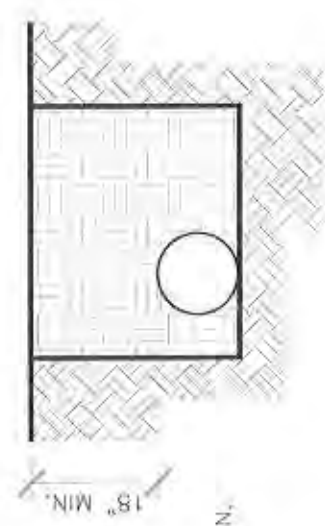

PRESSURE MAIN LINE

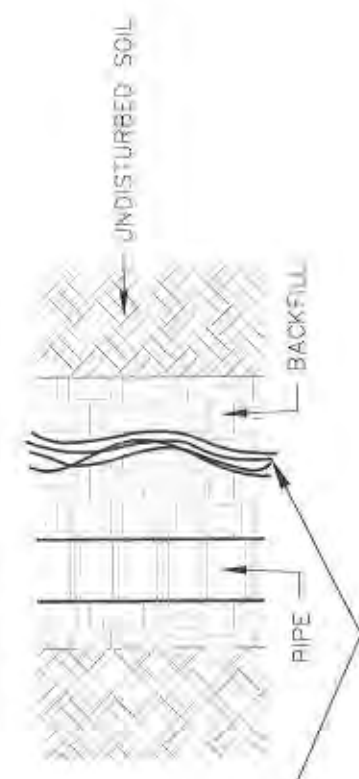

INSTALL #12 COPPER TRACE WIRE IN MAINLINE TRENCH, LEAVE 18" LOOP MINIMUM EXPOSED IN EACH VALVE BOX, SOLDER ANY SPLICES INTRACE WIRE.

CONTROL WIRES, BACKFILL HALF DIAMETER OF MAIN LINE, SET WIRES ADJACENT AND MAINTAIN A MINIMUM 4" SEPERATION BETWEEN CONTROL WIRES AND MAIN LINE. BUNDLE ALL WIRES TOGETHER AND TAPE AT (10') INTERVALS. CONTROL WIRES TO BE LAYED IN TRENCH IN SNAKE FASHION TO ALLOW FOR SETTLING AND MOVEMENT.



PIPE TRENCH

CORDOVA RECREATION AND PARK DISTRICT

SCALE: NOT TO SCALE
REVISED: JULY 2014

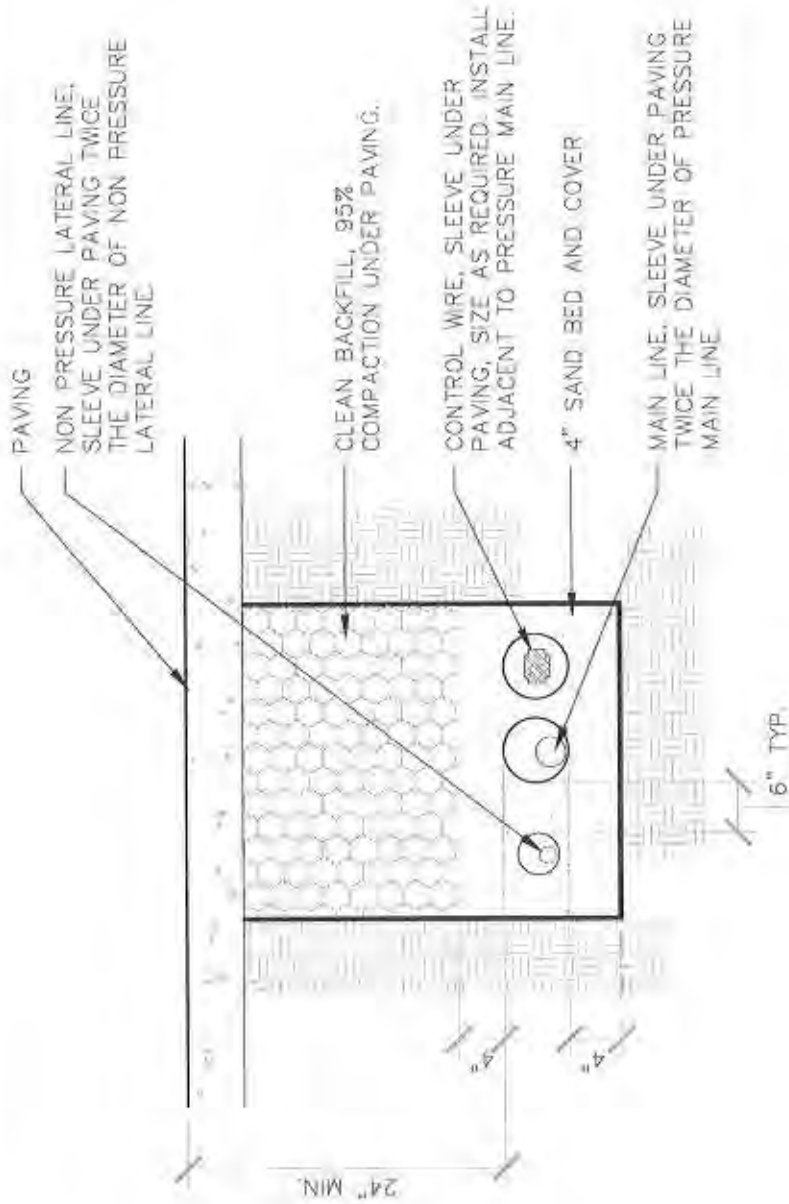

NOTES

1. ALL SLEEVES TO BE SCHEDULE 40 PVC.
2. EXTEND ALL SLEEVES 12" BEYOND EDGE OF HARDSCAPING.
3. CAP BOTH ENDS OF ALL SPARE SLEEVES AND MARK BOTH ENDS WITH 4x4 WOOD POST ABOVE GRADE.



SLEEVING AT PAVEMENT CROSSING

CORDOVA RECREATION AND PARK DISTRICT

SCALE: NOT TO SCALE
REVISED: JULY 2014

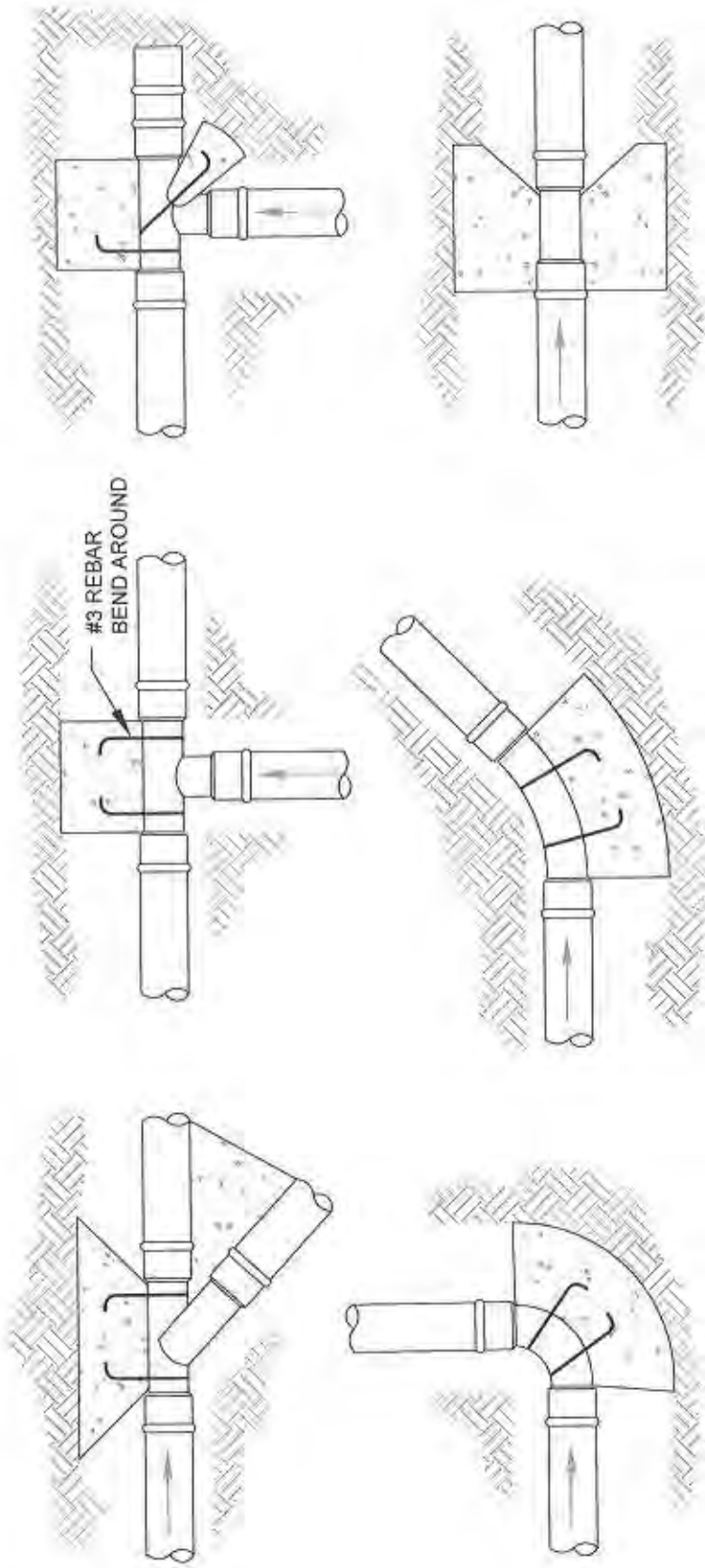

NOTES

1. DO NOT ENCASE CONTROL WIRES WITH CONCRETE.
2. SIZE THRUST BLOCKS AS SPECIFIED BY PIPE MANUFACTURER.
3. CONCRETE SHALL NOT COVER FITTING JOINTS
4. SUPPLY LINES 3" IN DAMETER AND LARGER OR GATE VALVES 2 1/2" OR LARGER SHALL RECEIVE CONCRETE THRUST BLOCKS.

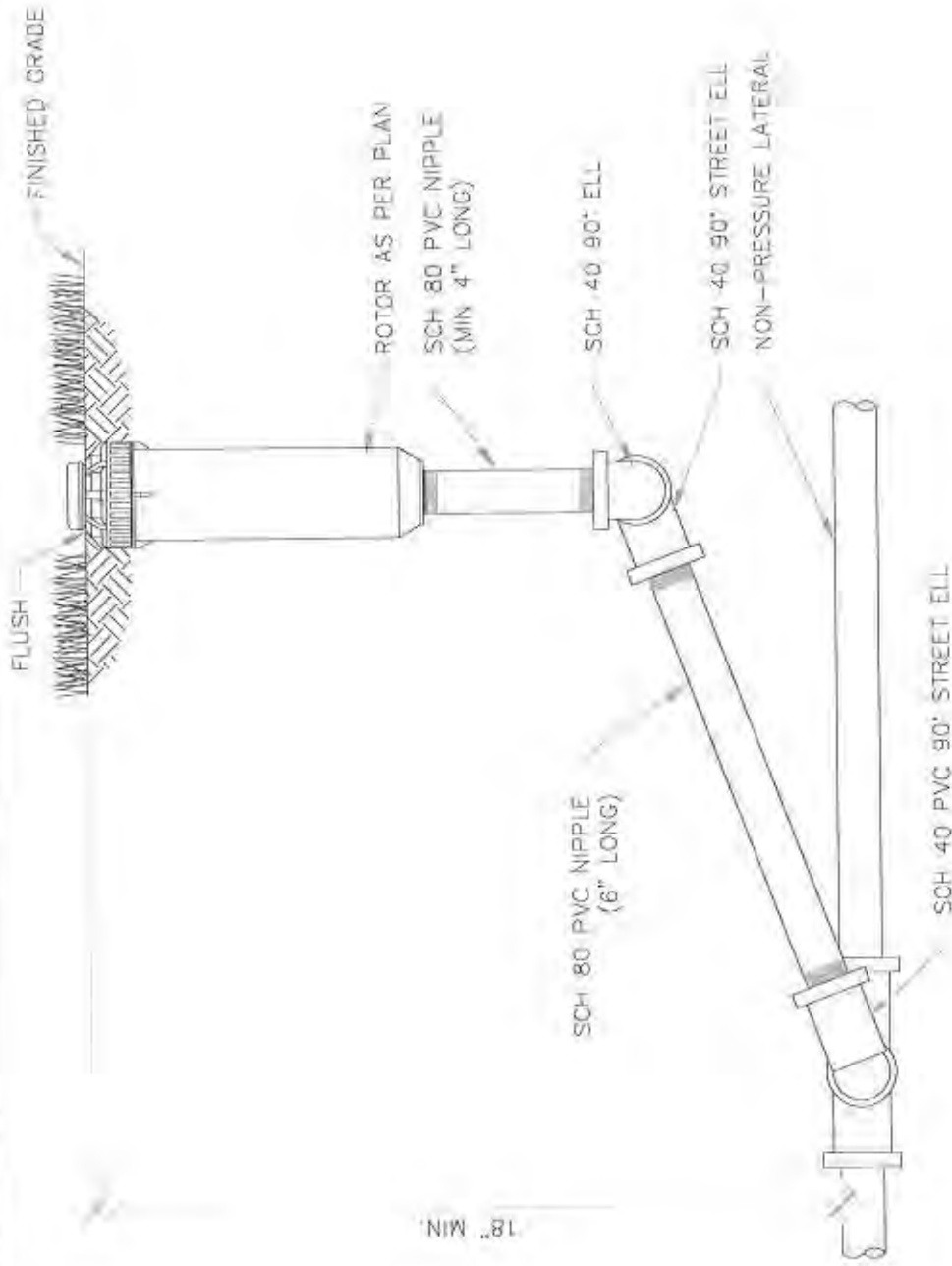

NOTES

1. LOCATE HEAD (1") FROM HARDSCAPE.
2. LOCATE HEAD (6") FROM ALL STRUCTURES.
3. USE TEFLON TAPE ON ALL THREADED FITTINGS. DO NOT USE MARLEX FITTINGS.
4. PREFABRICATED SWING JOINTS ARE ALLOWED, UPON CRPD APPROVAL.



POP-UP ROTOR

CORDOVA RECREATION AND PARK DISTRICT

SCALE: NOT TO SCALE
REVISED: JULY 2014

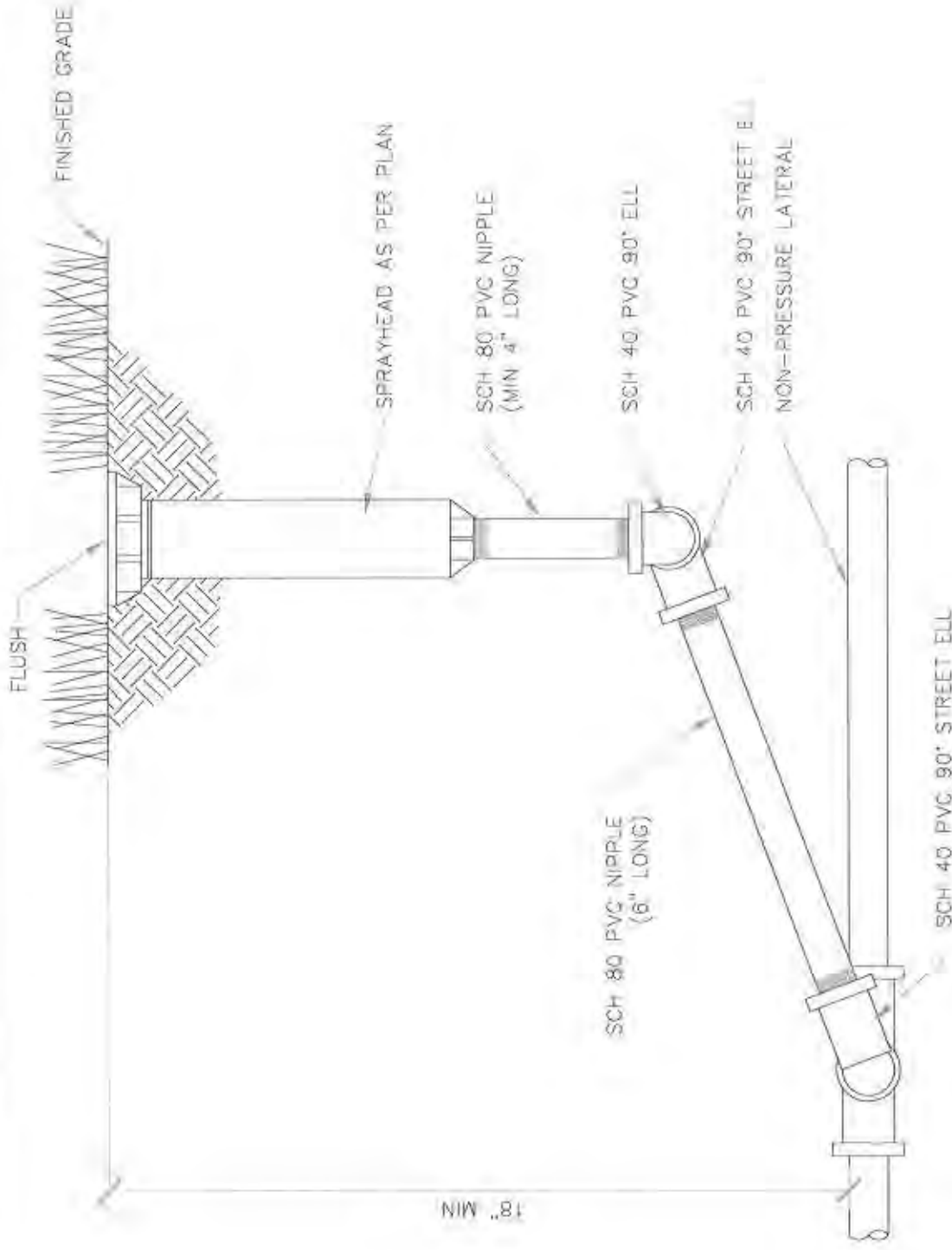

NOTES

1. LOCATE HEAD (1") FROM HARDSCAPE.
2. LOCATE SPRAY HEADS (6") FROM ALL STRUCTURES.
3. USE TEFLON TAPE ON ALL THREADED FITTINGS. DO NOT USE MARLEX FITTINGS.
4. PREFABRICATED SWING JOINT ARE ALLOWED, UPON CRPD APPROVAL.



POP-UP SPRAYHEAD

CORDOVA RECREATION AND PARK DISTRICT

SCALE: NOT TO SCALE
REVISED: JULY 2014

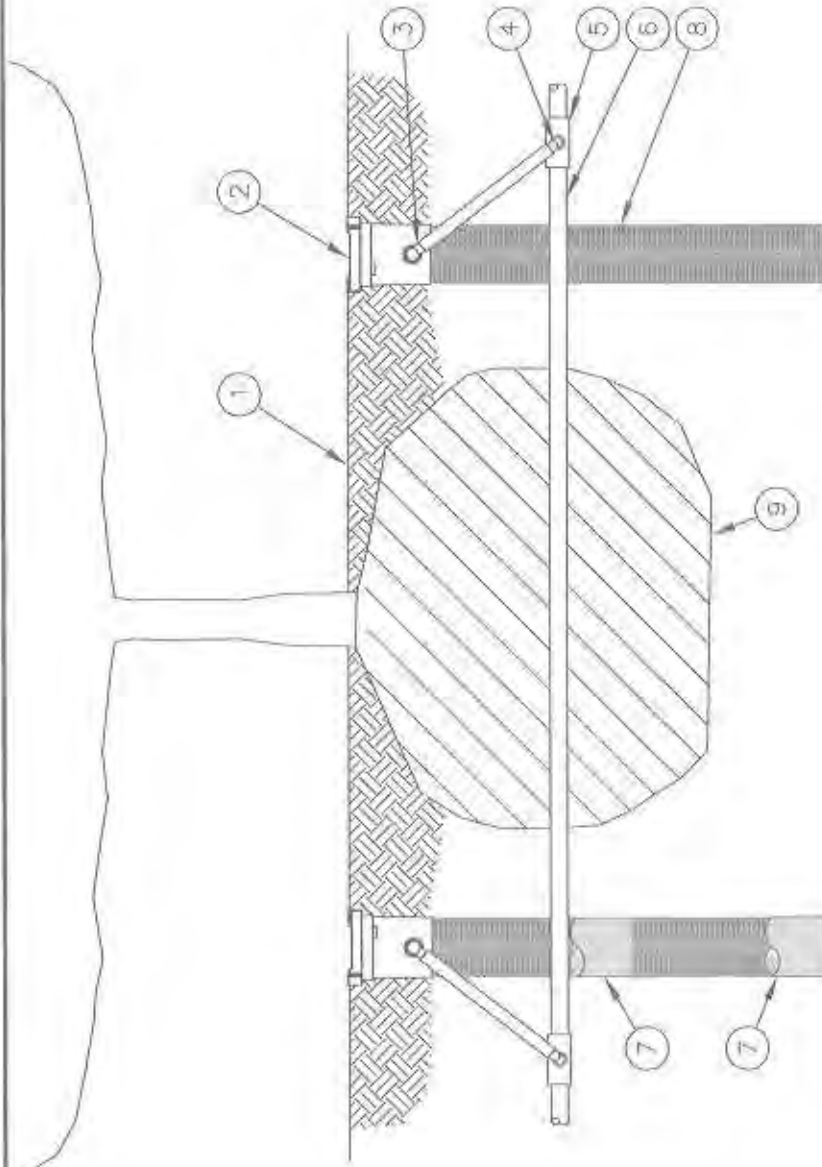

- ① FINISH GRADE/TOP OF MULCH
- ② ROOT WATERING SYSTEM: RAIN BIRD RWS-BG
- ③ 1/2" (1,3 CM) SPIRAL BARB FITTING (INCLUDED)
- ④ 1/2" (1,3 CM) SWING PIPE: RAIN BIRD SP SERIES WITH 1/2" (1,3 CM) MALE NPT & 0.490" BARB ELBOW. RAIN BIRD SBE-050
- ⑤ PVC SCH 40 TEE OR EL
- ⑥ PVC OR POLYETHYLENE LATERAL PIPE
- ⑦ OPTIONAL SOCK (RWS-SOCK) FOR SANDY SOILS
- ⑧ 4" (10,2 CM) WIDE X 18" (45,7 CM) LONG RIGID BASKET WEAVE CANISTER (INCLUDED)
- ⑨ PLANT ROOT BALL

NOTES:

- 1. POSITION 2-3 UNITS (OR MORE) EVENLY SPACED AROUND PLANT. FOR NEW TREES PLACE NEAR ROOT BALL. FOR EXISTING TREES PLACE HALF THE DISTANCE BETWEEN CANOPY EDGE AND TREE TRUNK.
- 2. INSTALL PRODUCT WITH TOP EVEN WITH GROUND SURFACE.
- 3. CONTRACTOR SHALL USE MODEL NUMBER RWS-BG - 4" X 36" SYSTEM WITH BUBBLE, 12" SWING ASSEMBLY AND 1/2" MALE NPT INLET.
- 4. WHEN INSTALLING IN EXTREMELY HARD OR CLAY SOILS, ADD 3/4" (1,9 CM) GRAVEL UNDER AND AROUND THE UNIT TO ALLOW FASTER WATER INFILTRATION AND ROOT PENETRATION.
- 5. ONCE RWS HAS BEEN INSTALLED FILL THE BASKET WITH PEA GRAVEL BEFORE LOCKING LID.
- 6. OPTIONAL RWS-SOCK FOR USE IN SANDY SOILS.



TREE BUBBLER

CORDOVA RECREATION AND PARK DISTRICT

SCALE: NOT TO SCALE
REVISED: JULY 2014

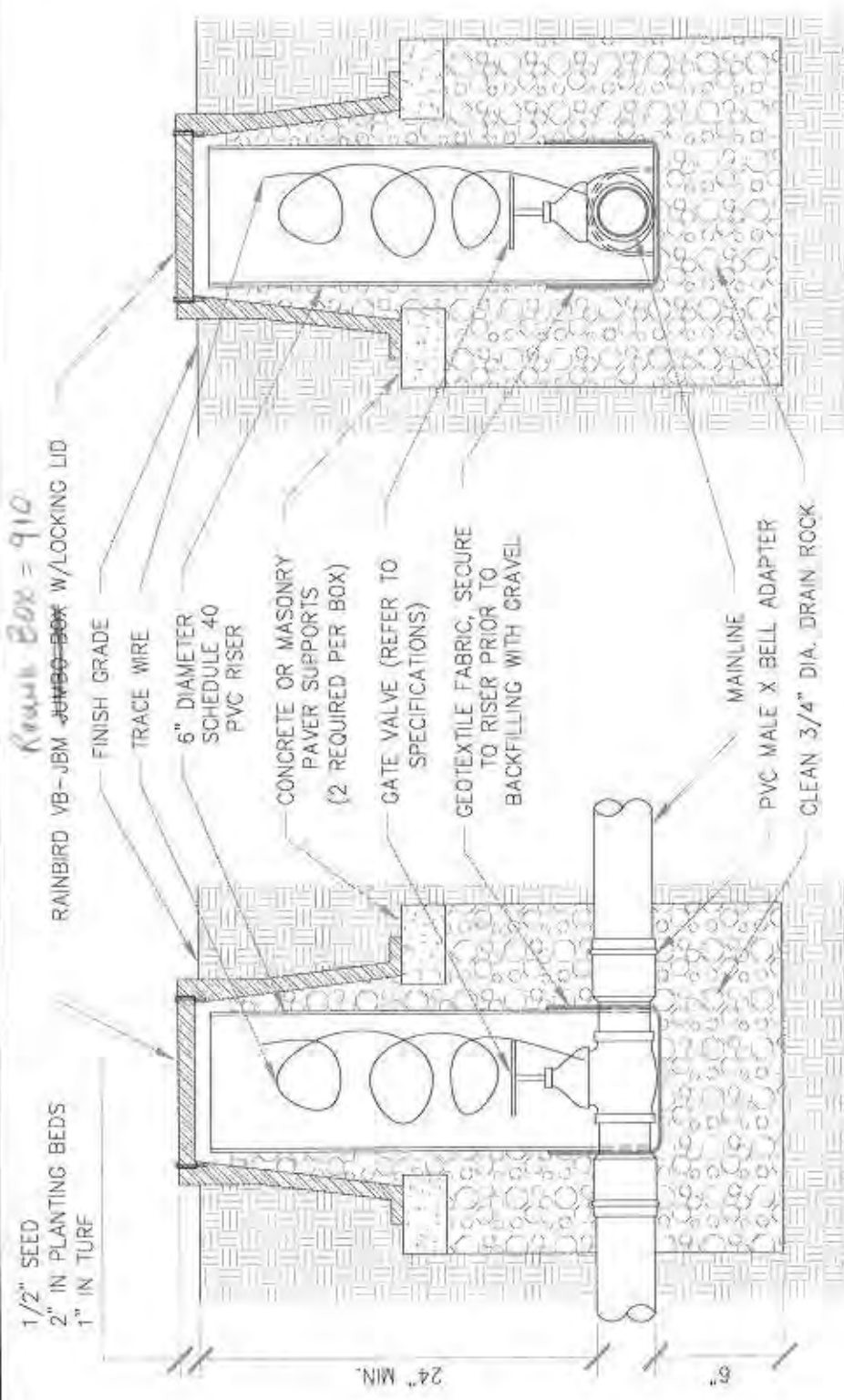

RAINBIRD VB-JBM ~~W/LOCKING LID~~ *Round Box = 910*

1/2" SEED
2" IN PLANTING BEDS
1" IN TURE

FINISH GRADE

TRACE WIRE

6" DIAMETER
SCHEDULE 40
PVC RISER

CONCRETE OR MASONRY
PAVER SUPPORTS
(2 REQUIRED PER BOX)

GATE VALVE (REFER TO
SPECIFICATIONS)

GEOTEXTILE FABRIC, SECURE
TO RISER PRIOR TO
BACKFILLING WITH GRAVEL

MAINLINE

PVC MALE X BELL ADAPTER

CLEAN 3/4" DIA. DRAIN ROCK

24" MIN.

6"

NOTES

1. COMPACT SOIL AROUND BOX TO 90% MINIMUM COMPACTION
2. PLACE DRAIN ROCK PRIOR TO INSTALLING VALVE BOX.
3. GATE VALVE AND FITTINGS SHALL BE LINE SIZE UNLESS OTHERWISE NOTED.
4. USE TEFLON TAPE ON ALL THREADED FITTINGS.
5. LOCATE VALVES IN SHRUB/GROUNDCOVER AREAS WHENEVER POSSIBLE.
6. LOOP 36" EXTRA TRACER WIRE UP INSIDE BOX.



3" AND SMALLER GATE VALVE
CORDOVA RECREATION AND PARK DISTRICT

SCALE: NOT TO SCALE
REVISED: JULY 2014

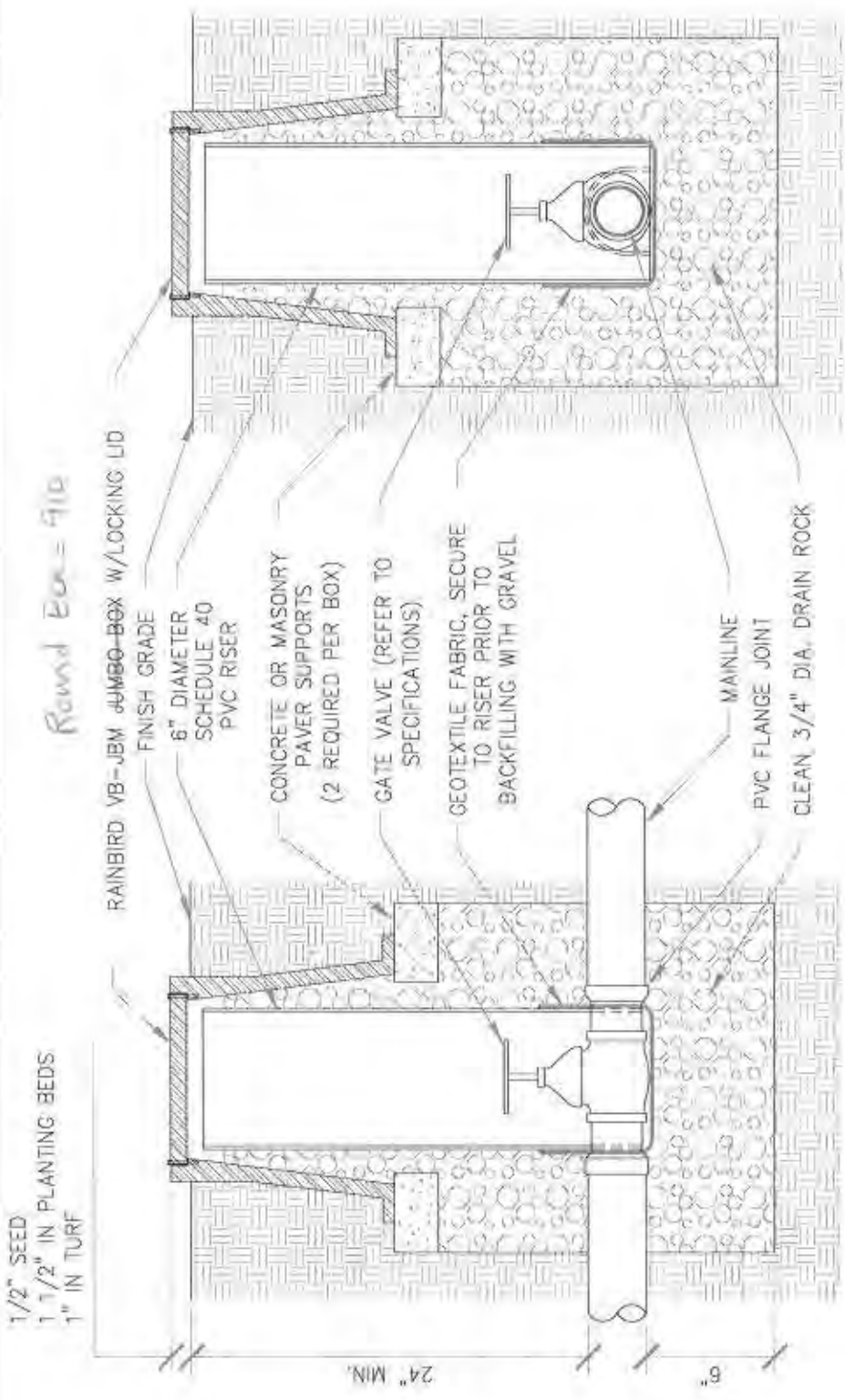

NOTES

1. COMPACT SOIL AROUND BOX TO 90% MINIMUM COMPACTION.
2. PLACE DRAIN ROCK PRIOR TO INSTALLING VALVE BOX.
3. GATE VALVE AND FITTINGS SHALL BE LINE SIZE UNLESS OTHERWISE NOTED.
4. USE TEFLON TAPE ON ALL THREADED FITTINGS.
5. LOCATE VALVES IN SHRUB/GROUND COVER AREAS WHENEVER POSSIBLE.
6. LOOP (36") EXTRA TRACER WIRE UP INSIDE BOX.



3" AND LARGER GATE VALVE
CORDOVA RECREATION AND PARK DISTRICT

SCALE: NOT TO SCALE
 REVISED: JULY 2014

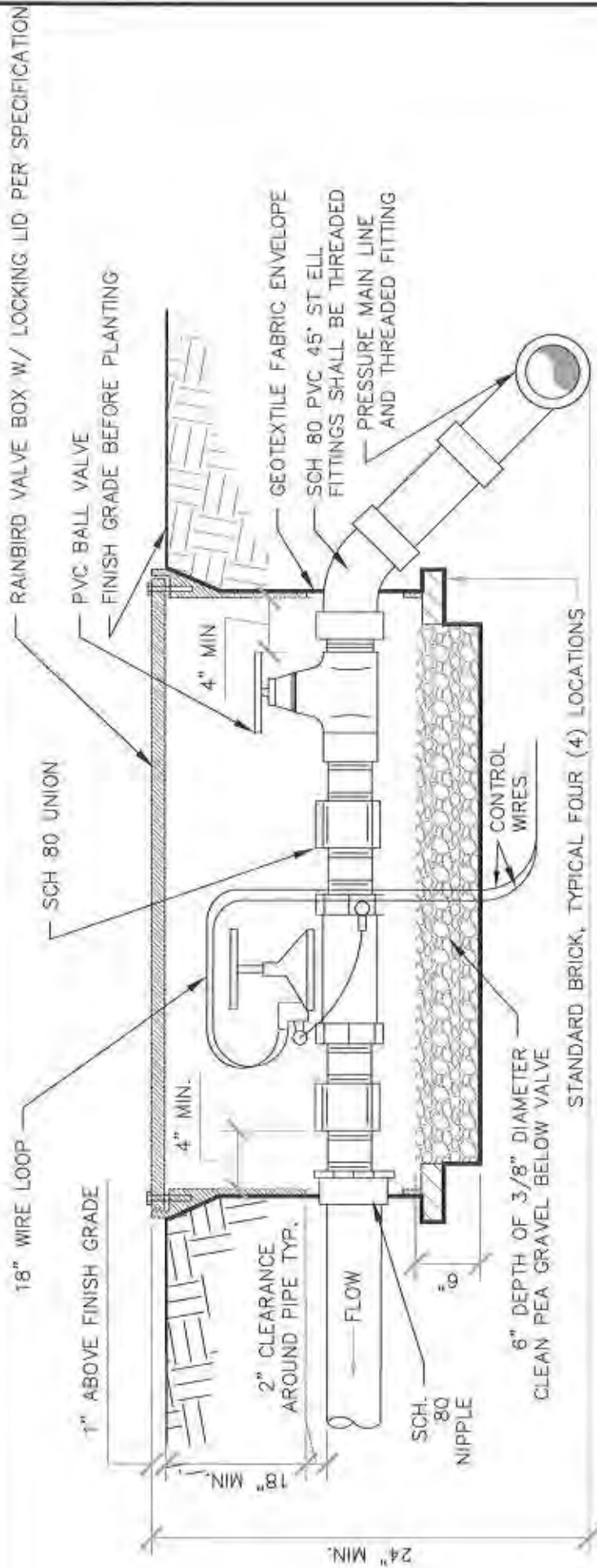

NOTES

1. INSTALL VALVES A MINIMUM OF 12" FROM STRUCTURES OR HARDSCAPING.
2. INSTALL VALVES IN PLANT BEDS WHEREVER POSSIBLE.
3. PLACE VALVE BOX AT RIGHT ANGLES TO STRUCTURES OR HARDSCAPING.
4. INSTALL VALVE BOX SO THAT TOP OF BOX IS FLUSH WITH ADJACENT HARDSCAPING.
5. USE TEFLON TAPE ON ALL MALE THREADS.
6. ALL RCV'S SHALL BE TAGGED INDICATING STATION #'S. ALL VALVE BOXES SHALL HAVE STATION #'S PERMANENTLY MARKED ON VALVE BOX LIDS, HEAT BRANDED ONLY.
7. PROVIDE SCHEDULE 80 THREADED UNION ON UPSTREAM AND DOWNSTREAM SIDES.
8. REFER TO SPECIFICATIONS FOR REQUIREMENTS FOR TAPING, EXPANSION COILS, WIRE CONNECTIONS, ETC.
9. ALL THREADED FITTINGS SHALL BE SCH. 80



REMOTE CONTROL VALVE AT GRADE

CORDOVA RECREATION AND PARK DISTRICT

SCALE: NOT TO SCALE
REVISED: JULY 2014

DOMESTIC WATER MAIN

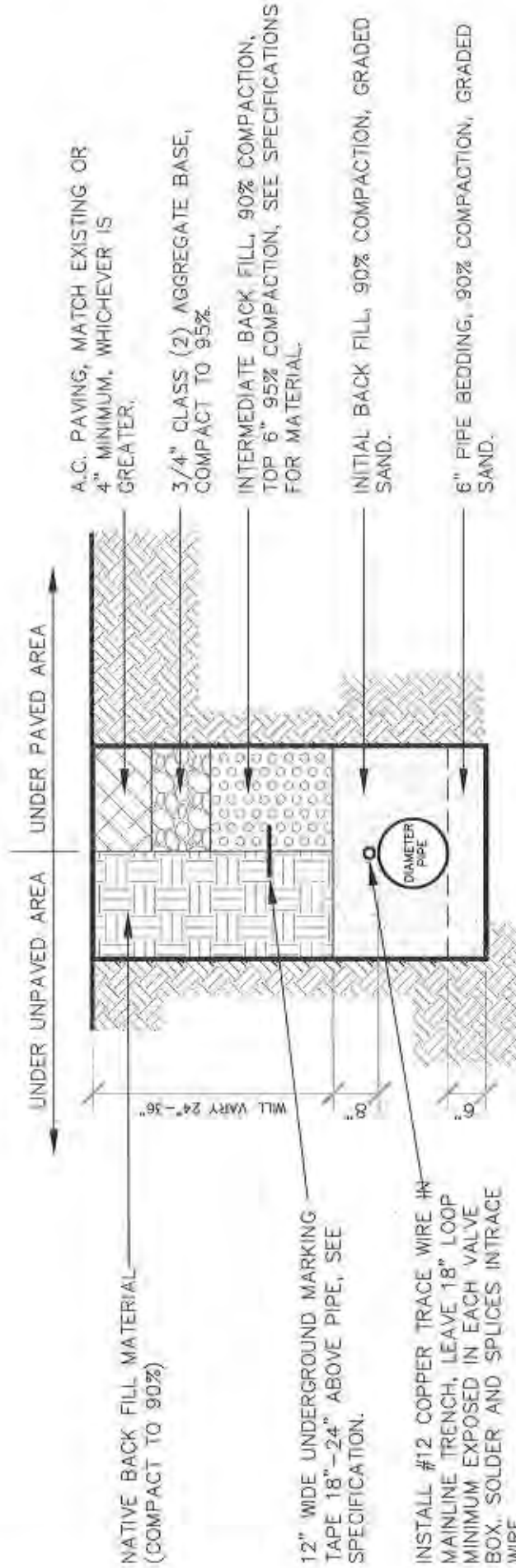

NOTES:

- SEE CRPD SPECIFICATION AND PROJECT WATER NOTES FOR REQUIREMENTS.
- 6" AND 8" DIMENSIONS SHALL INCLUDE DISTANCE BETWEEN PIPE BELL AND TRENCH WALL.
- PLACE INITIAL SAND BACK FILL TO TOP OF PIPE, SPRAY WITH WATER TO COMPACT. THEN PLACE INITIAL SAND BACK FILL TO AT LEAST 8" ABOVE TOP OF PIPE, SPRAY WITH WATER TO COMPACT. AFTER SPRAYING WITH WATER, USE MECHANICAL COMPACTION METHODS IF NEEDED.
- COORDINATE COMPACTION TESTS WITH CRPD CONSTRUCTION MANAGER.
- JETTING WILL NOT BE ALLOWED FOR COMPACTION OF BACK FILL OR PIPE BEDDING MATERIAL.
- IN UNPAVED AREAS, PIPE BEDDING MATERIAL, AND INITIAL BACK FILL MATERIALS SHALL BE COMPACTED THE SAME AS IN PAVED AREAS.



DOMESTIC WATER MAIN

CORDOVA RECREATION AND PARK DISTRICT

SCALE: NOT TO SCALE
REVISED: JULY 2014

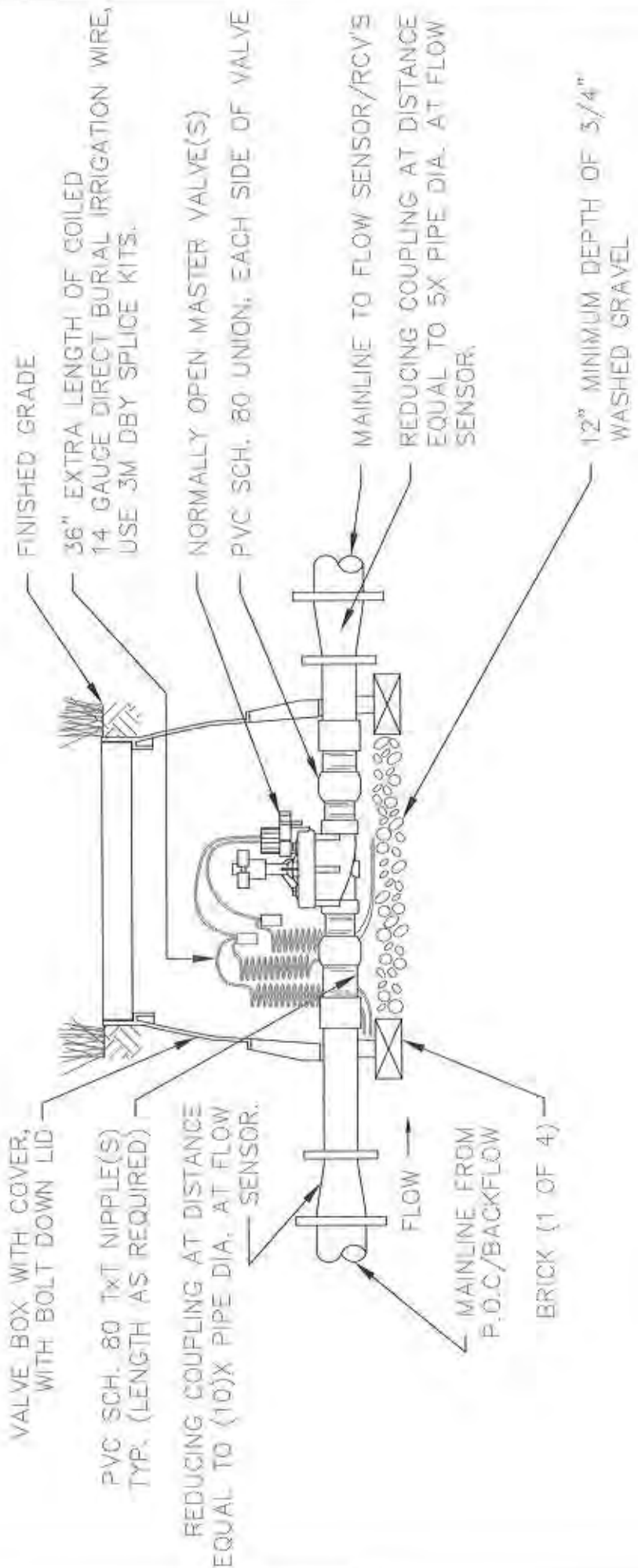

MASTER REMOTE CONTROL VALVE

CORDOVA RECREATION AND PARK DISTRICT

SCALE: NOT TO SCALE
 REVISED: JULY 2014

AUTOMATIC SPRINKLER CONTROL UNIT, SECURE TO A VANDAL RESISTANT ENCLOSURE AND SECURE ENCLOSURE TO A CONCRETE PAD. SEE IRRIGATION LEGEND FOR MANUFACTURER AND MODEL NUMBER OF CONTROLLER AND ENCLOSURE.

COLOR CODED LAMINATED MAP FOR VALVE LOCATIONS INSIDE (SEE SPECS.)

CONNECT CONTROL AND COMMON WIRES TO TERMINAL STRIPS IN ENCLOSURE. ALLOW FOR EXPANSION LOOP.

ON-OFF SWITCH AND 120 VOLT GFI WEATHERPROOF OUTLET. (LOCATE INSIDE ENCLOSURE)

FINISH GRADE

DEPTH OF CONDUIT PER LOCAL CODE

ELECTRICAL CONDUIT PER CODE TO POWER SOURCE
 8' LONG, COPPER CLAD GROUNDING ROD SLEEVED WITH PVC PRIOR TO POURING CONCRETE.
 CONTROL WIRING (AWG. UF), SECURE TO TERMINAL STRIP PROVIDED IN ENCLOSURE. PROVIDE 3" DIA. MINIMUM PVC CONDUIT FOR WIRES. EXTEND 6" BEYOND EDGE OF CONCRETE PAD.

1" MIN.
 2" MIN.
 6" MIN.

6" MIN.

1" MIN.

2" MIN.

PROVIDE 2" DIA. MINIMUM PVC CONDUIT, EXTEND 6" BEYOND EDGE OF CONCRETE PAD FOR PHONE POC.

NOTES

1. COMMON WIRE TO BE WHITE & CONTROL WIRE TO BE RED IN COLOR. BUNDLE AND TAPE AT INTERVALS OF (10') O. C.
2. NO SPLICES SHALL BE MADE BETWEEN CONTROLLER AND REMOTE CONTROL VALVES UNDER (500) LINEAR FEET AT GRADE IN VALVE BOX.
3. REFER TO SPECIFICATIONS AND PLAN SHEETS FOR MORE INFORMATION.



CONTROLLER

CORDOVA RECREATION AND PARK DISTRICT

SCALE: NOT TO SCALE
 REVISED: JULY 2014

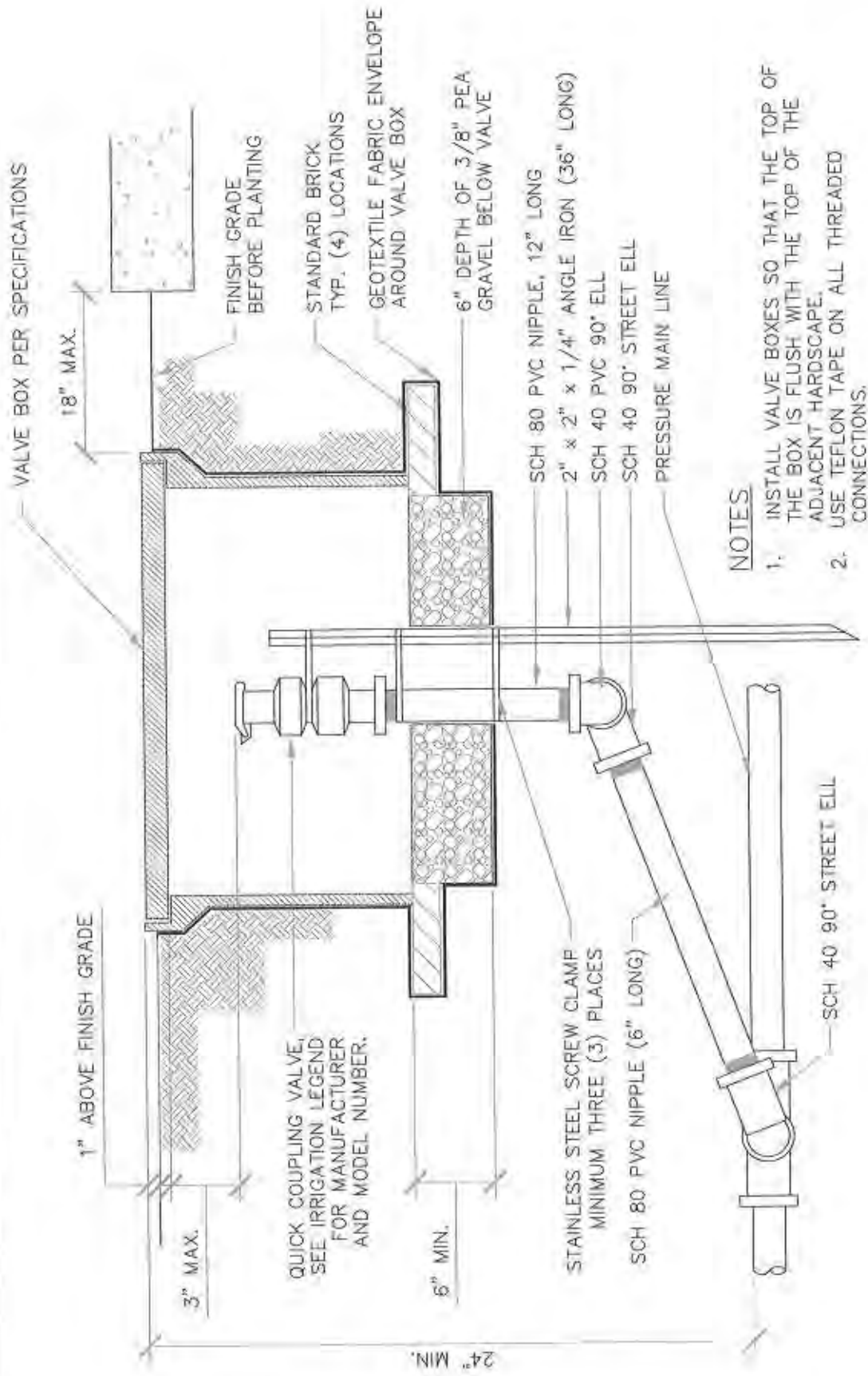

NOTES

1. INSTALL VALVE BOXES SO THAT THE TOP OF THE BOX IS FLUSH WITH THE TOP OF THE ADJACENT HARDSCAPE.
2. USE TEFLON TAPE ON ALL THREADED CONNECTIONS.

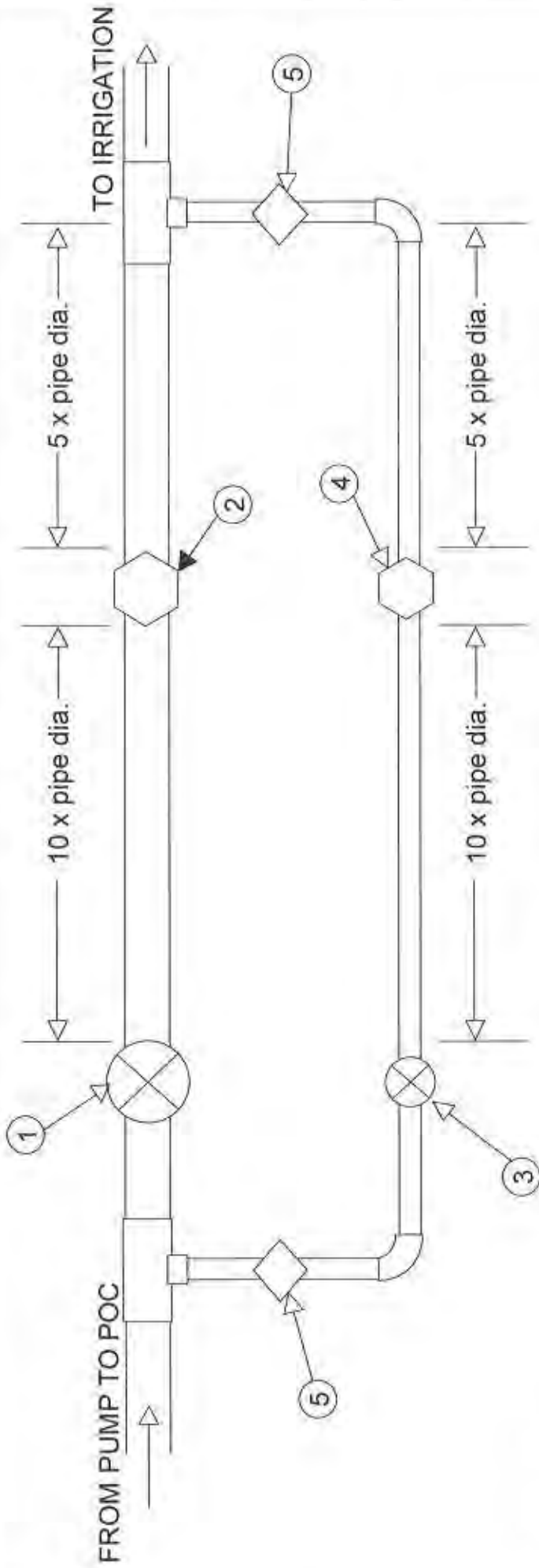

LEGEND

- ① NORMALLY CLOSED MASTER SOLENOID CONTROL VALVE
- ② LOW FLOW SENSOR #2
- ③ NORMALLY OPEN MASTER SOLENOID VALVE
- ④ FLOW SENSOR #1
- ⑤ BALL VALVE



MASTER FLOW VALVE WITH SENSOR

CORDOVA RECREATION AND PARK DISTRICT

SCALE: NOT TO SCALE
REVISED: JULY 2014

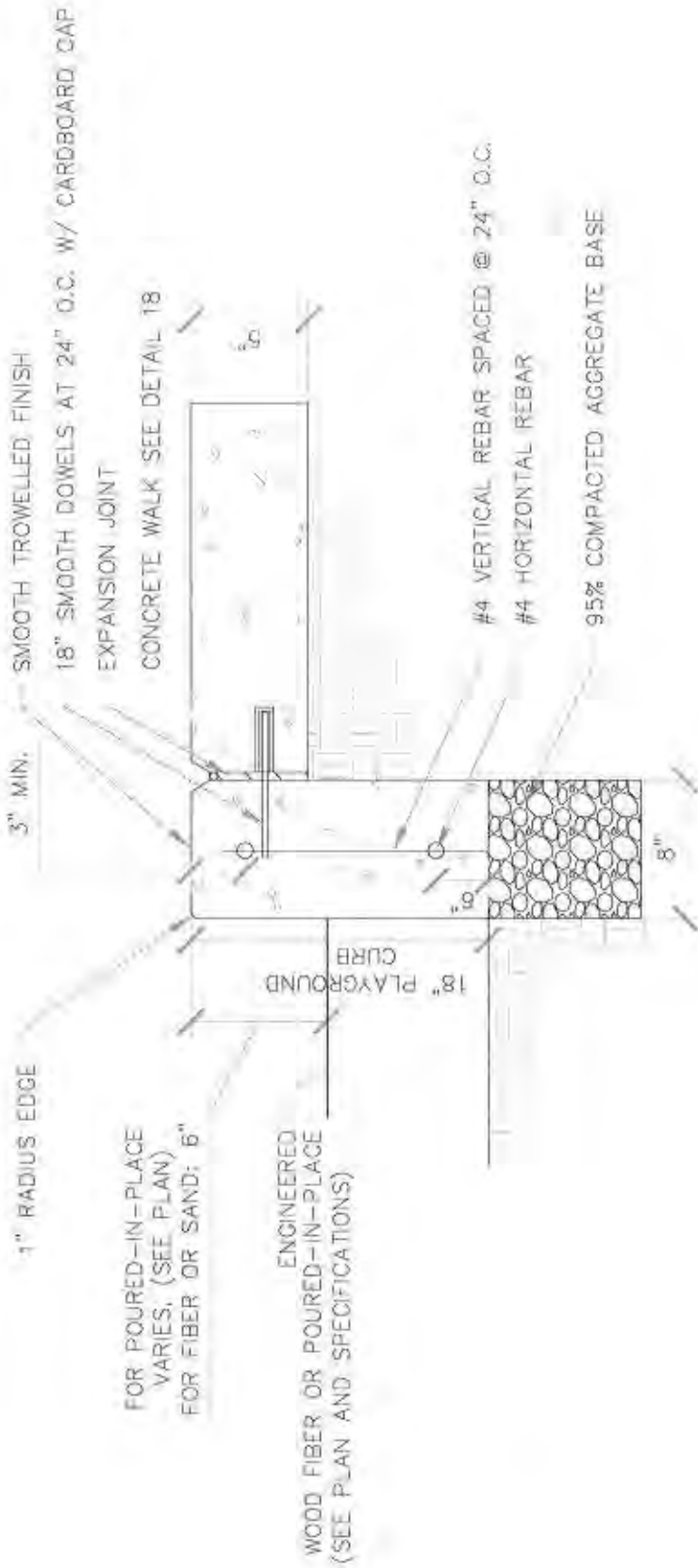

NOTE

- 1. INSTALL TYPE 3 CONCRETE CURB AND CONCRETE PAVING.
- 2. PROVIDE 18" SMOOTH DOWELS AT 24" O.C.
- 3. PROVIDE VERTICAL SCORE JOINTS (1" DEEP) AT HORIZONTAL SCORE LINES.



CONCRETE CURB AT PLAY AREAS

CORDOVA RECREATION AND PARK DISTRICT

SCALE: NOT TO SCALE
REVISED: JULY 2014

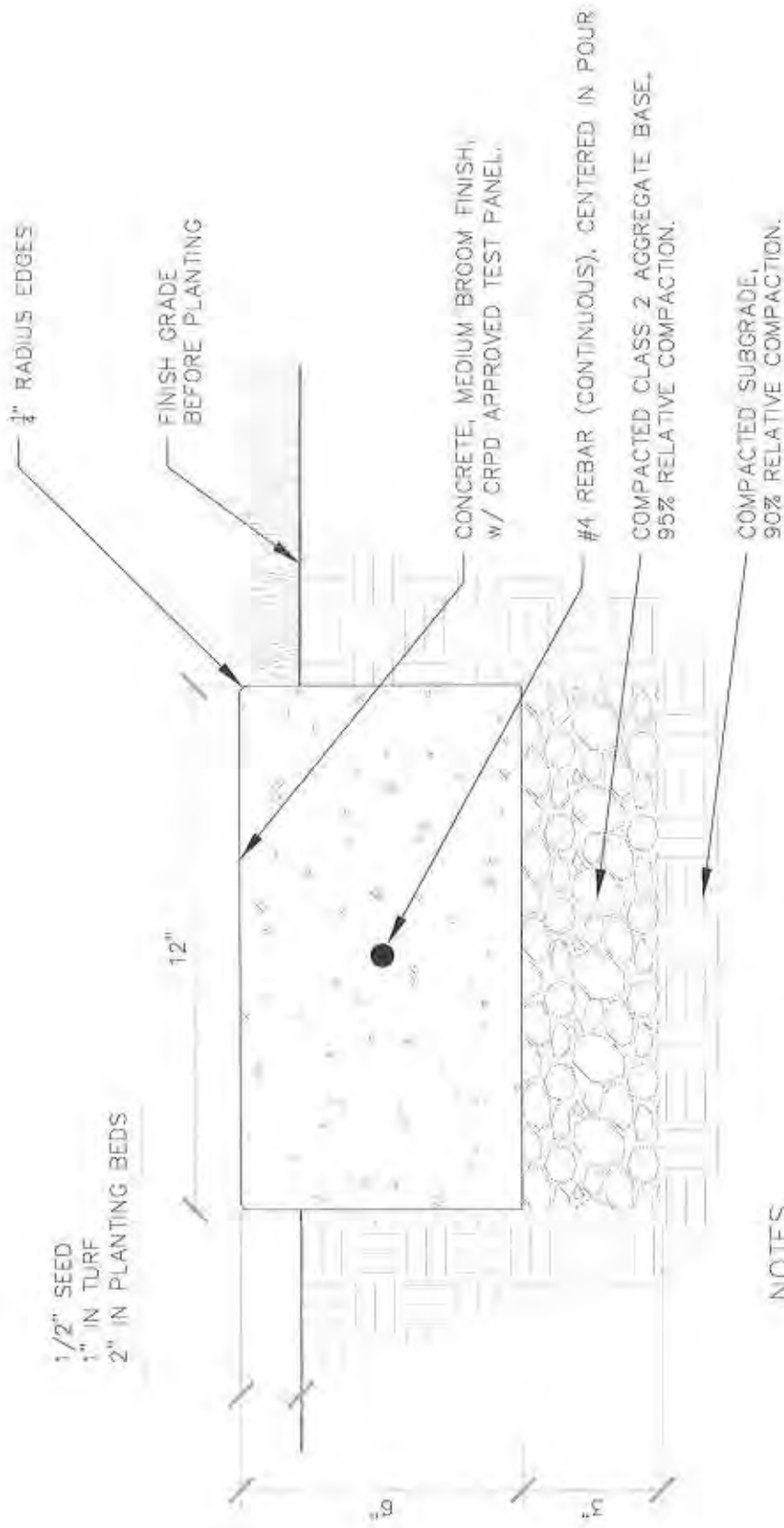

NOTES

- 1. PROVIDE 1/2" SCORE JOINTS AT (10') O.C



CONCRETE MOW CURB
CORDOVA RECREATION AND PARK DISTRICT

SCALE: NOT TO SCALE
REVISED: JULY 2014

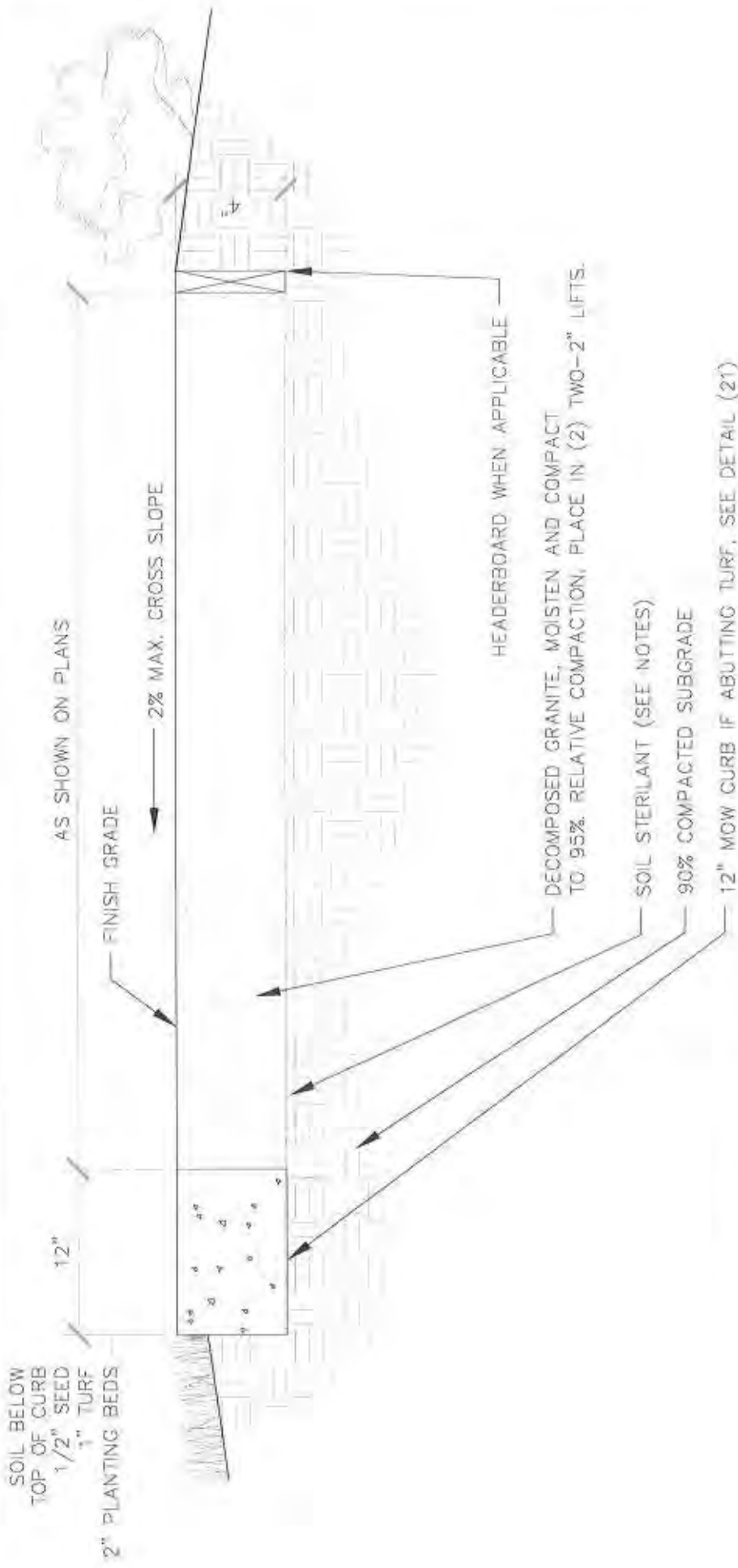

NOTES

1. CONTRACTOR TO SUBMIT SAMPLE OF LIGHT TAN OR CALIFORNIA GOLD DECOMPOSED GRANITE FOR APPROVAL BY CRPD.
2. SEE SPECIFICATIONS FOR BINDER MATERIAL.
3. APPLY RONSTAR OR SURFLAN TO COMPACTED SUBGRADE SURFACE PRIOR TO DG INSTALLATION.



DECOMPOSED GRANITE PAVING

CORDOVA RECREATION AND PARK DISTRICT

SCALE: NOT TO SCALE
REVISED: JULY 2014

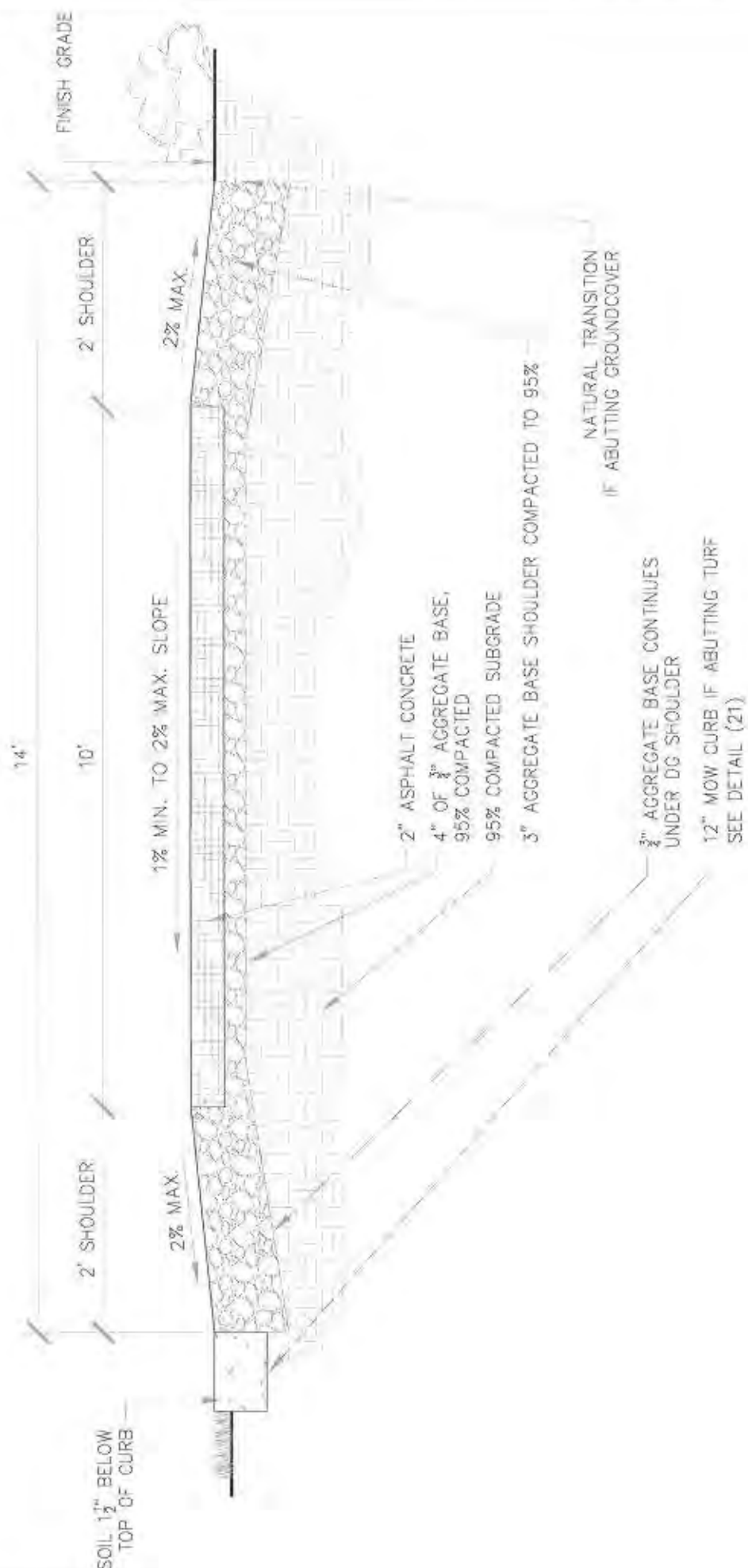

BIKE TRAIL SECTION

CORDOVA RECREATION AND PARK DISTRICT

SCALE: NOT TO SCALE
REVISED: JULY 2014

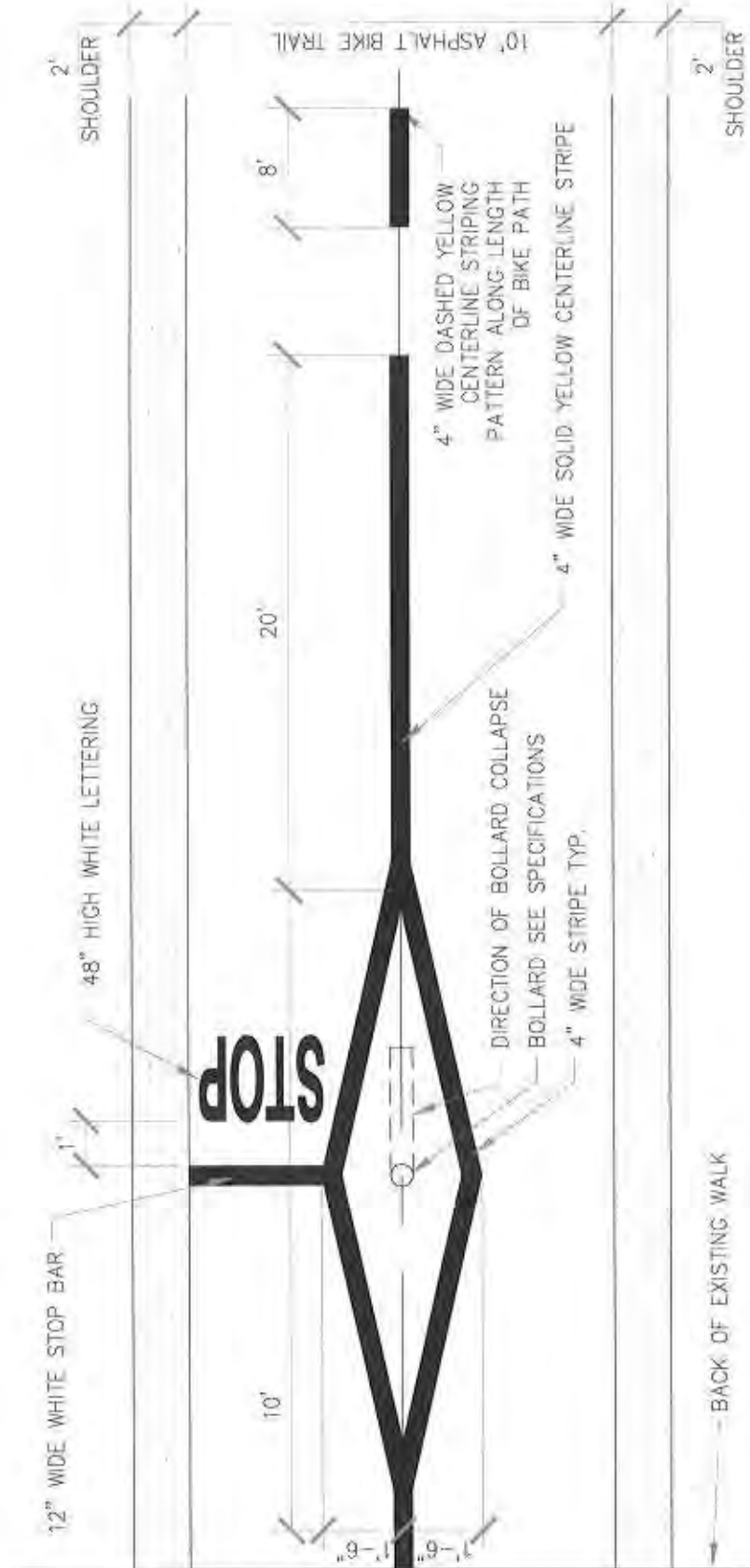

NOTES

1. STRIPING SHALL CONFORM WITH CALTRANS HIGHWAY DESIGN MANUAL JULY 1990, SECTIONS 1004.2, 1003.1.15 AND 1003.16 AS WELL AS CRPD STANDARDS.



BIKE TRAIL STRIPING
CORDOVA RECREATION AND PARK DISTRICT

SCALE: NOT TO SCALE
REVISED: JULY 2014

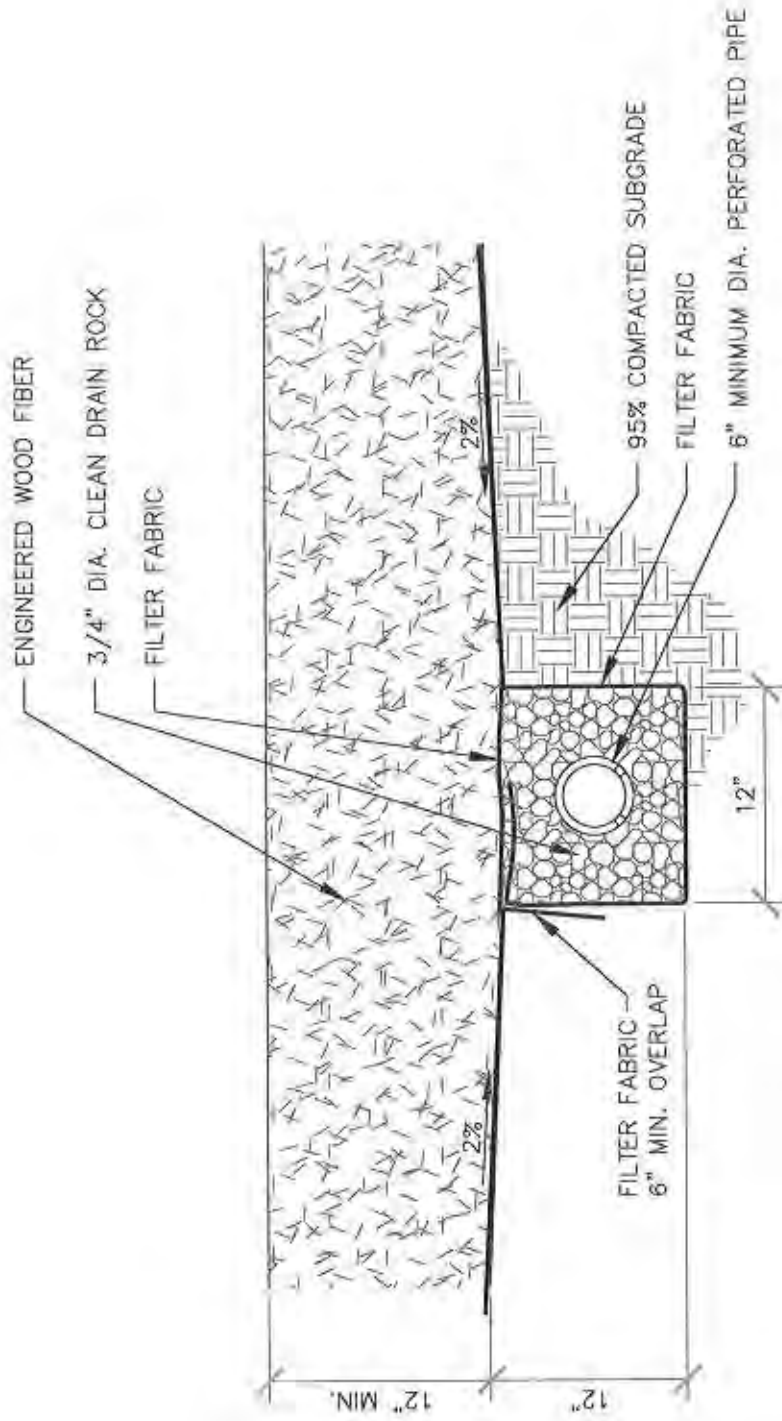

NOTES

1. PERFORATED PIPE SHALL BE LAID IN A HERRINGBONE PATTERN AND CONNECTED TO A DRAIN INLET.
2. LOCATE ALL CLEAN OUTS OUTSIDE PLAY AREA WITHIN PLANTING/TURF AREAS.
3. SHOW PERFORATED PIPE LAYOUT ON GRADING PLAN.
4. FILTER FABRIC SHALL BE MIRAFIT N-SERIES OR APPROVED EQUAL.

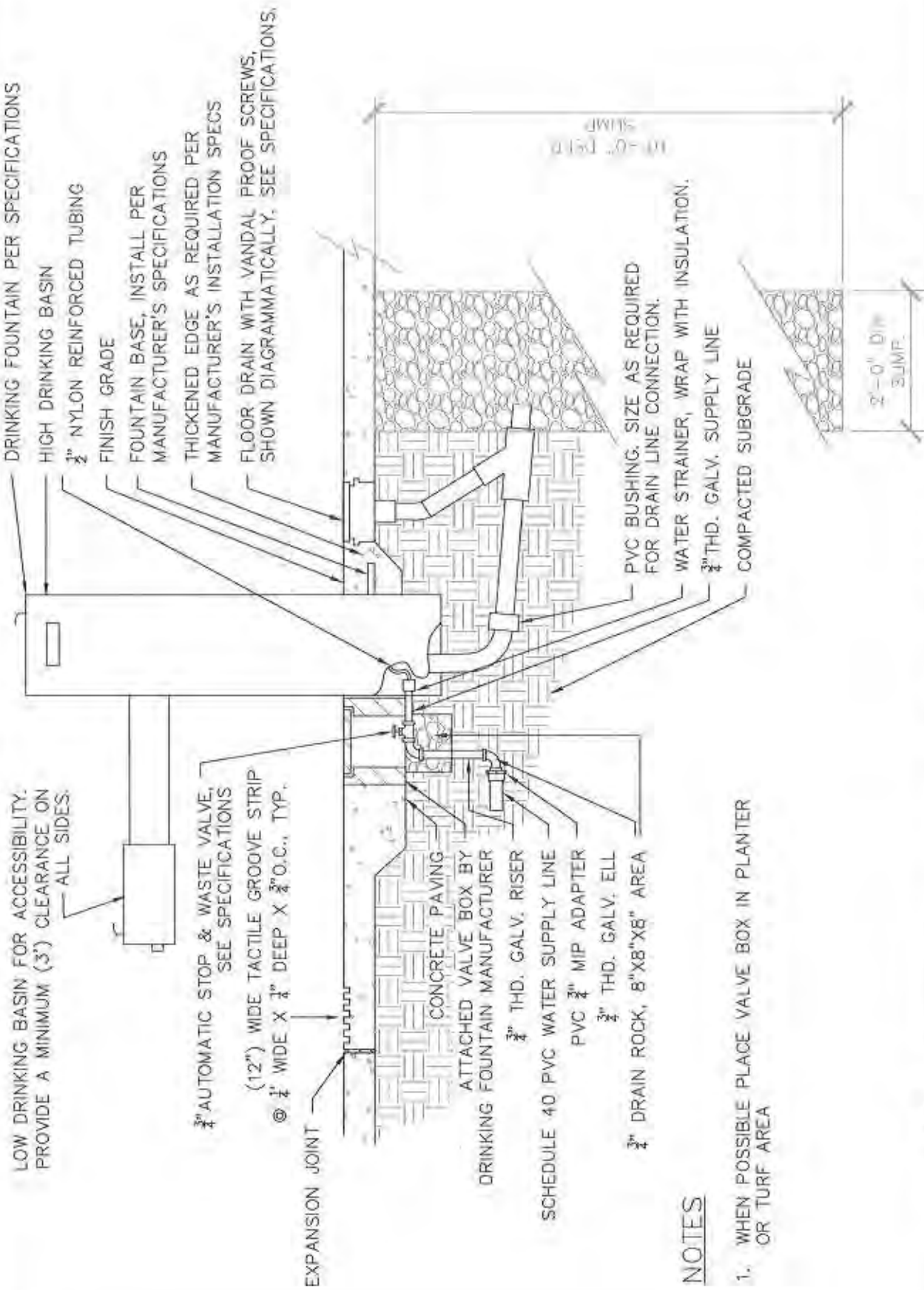

NOTES

1. WHEN POSSIBLE PLACE VALVE BOX IN PLANTER OR TURF AREA



DRINKING FOUNTAIN WITH SUMP
CORDOVA RECREATION AND PARK DISTRICT

SCALE: NOT TO SCALE
 REVISED: JULY 2014

SECTION

LOW DRINKING BASIN FOR ACCESSIBILITY.
 PROVIDE A MINIMUM (3') CLEARANCE ON
 ALL SIDES.

DRINKING FOUNTAIN PER SPECIFICATIONS

HIGH DRINKING BASIN

3/4" NYLON REINFORCED TUBING

FINISH GRADE

FOUNTAIN BASE, INSTALL PER
 MANUFACTURER'S SPECIFICATIONS

THICKENED EDGE AS REQUIRED PER
 MANUFACTURER'S INSTALLATION SPECS

FLOOR DRAIN WITH VANDAL PROOF SCREWS,
 SHOWN DIAGRAMMATICALLY. SEE SPECIFICATIONS.

3/4" AUTOMATIC STOP & WASTE VALVE,
 SEE SPECIFICATIONS

(12") WIDE TACTILE GROOVE STRIP
 @ 1/4" WIDE X 1/4" DEEP X 3/4" O.C., TYP.

EXPANSION JOINT

CONCRETE PAVING

ATTACHED VALVE BOX BY
 DRINKING FOUNTAIN MANUFACTURER

3/4" THD. GALV. RISER

SCHEDULE 40 PVC WATER SUPPLY LINE

PVC 3/4" MIP ADAPTER

3/4" THD. GALV. ELL

3/4" DRAIN ROCK, 8"X8"X8" AREA

ABS P-TRAP AS REQUIRED

PVC BUSHING. SIZE AS REQUIRED
 FOR DRAIN LINE CONNECTION.

WATER STRAINER, WRAP WITH INSULATION.

3/4" THD. GALV. SUPPLY LINE

COMPACTED SUBGRADE

NOTES

1. PROVIDE LINE SIZE TWO WAY CLEAN OUT EVERY 100' ON SANITARY SEWER LINE.
2. WHERE POSSIBLE LOCATE VALVE BOX IN PLANTER OR TURF.



DRINKING FOUNTAIN

CORDOVA RECREATION AND PARK DISTRICT

SCALE: NOT TO SCALE
 REVISED: JULY 2014

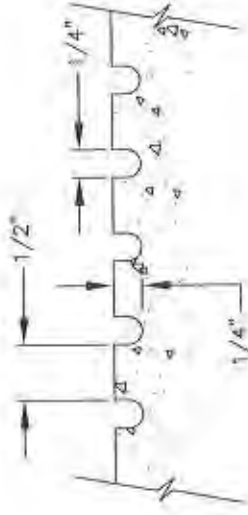
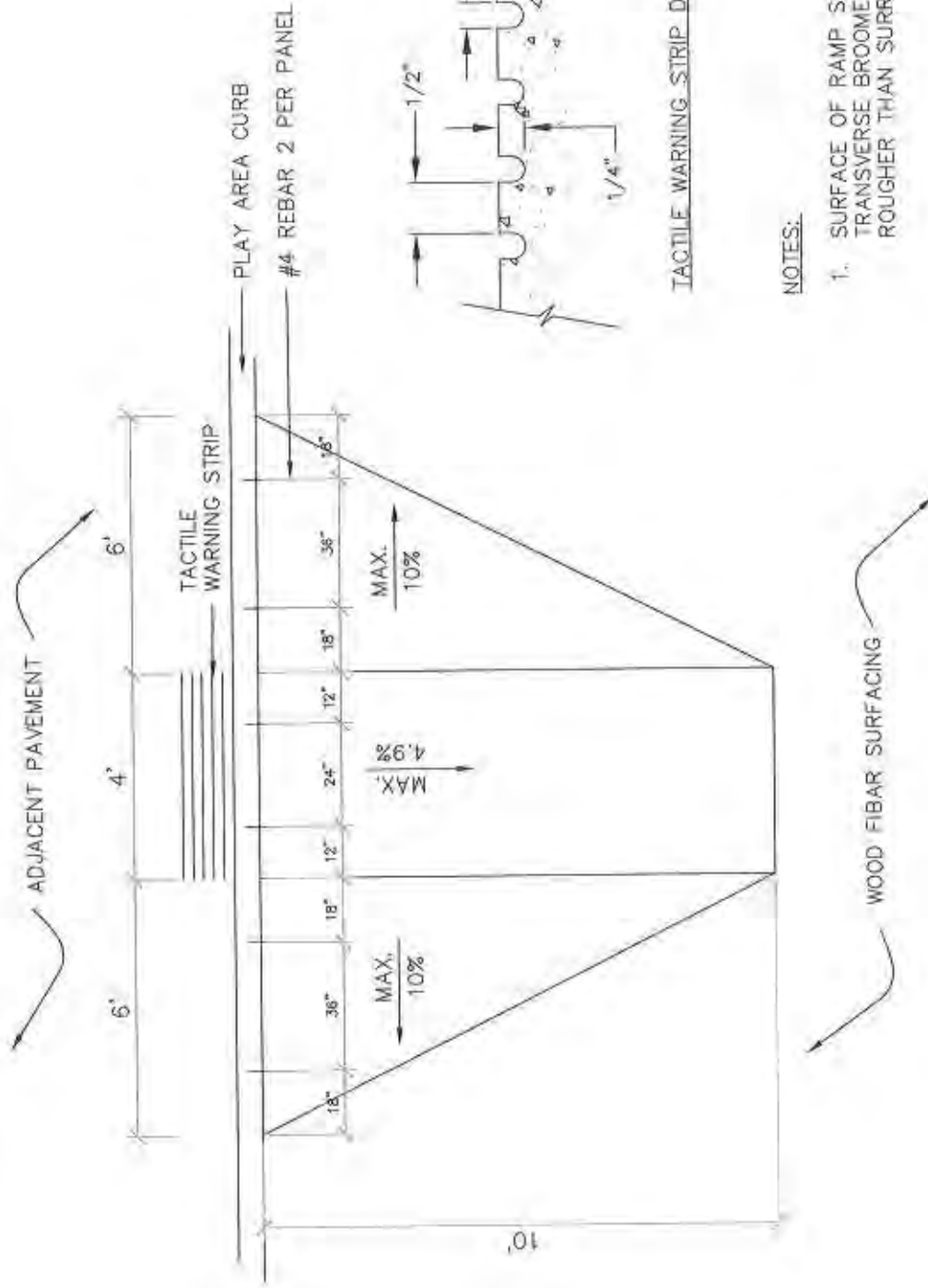

TACTILE WARNING STRIP DETAIL

NOTES:

1. SURFACE OF RAMP SHALL BE A TRANSVERSE BROOMED TEXTURE ROUGHER THAN SURROUNDING SIDEWALK



PLAY AREA RAMP -- PLAN
CORDOVA RECREATION AND PARK DISTRICT

SCALE: NOT TO SCALE
REVISED: JULY 2014

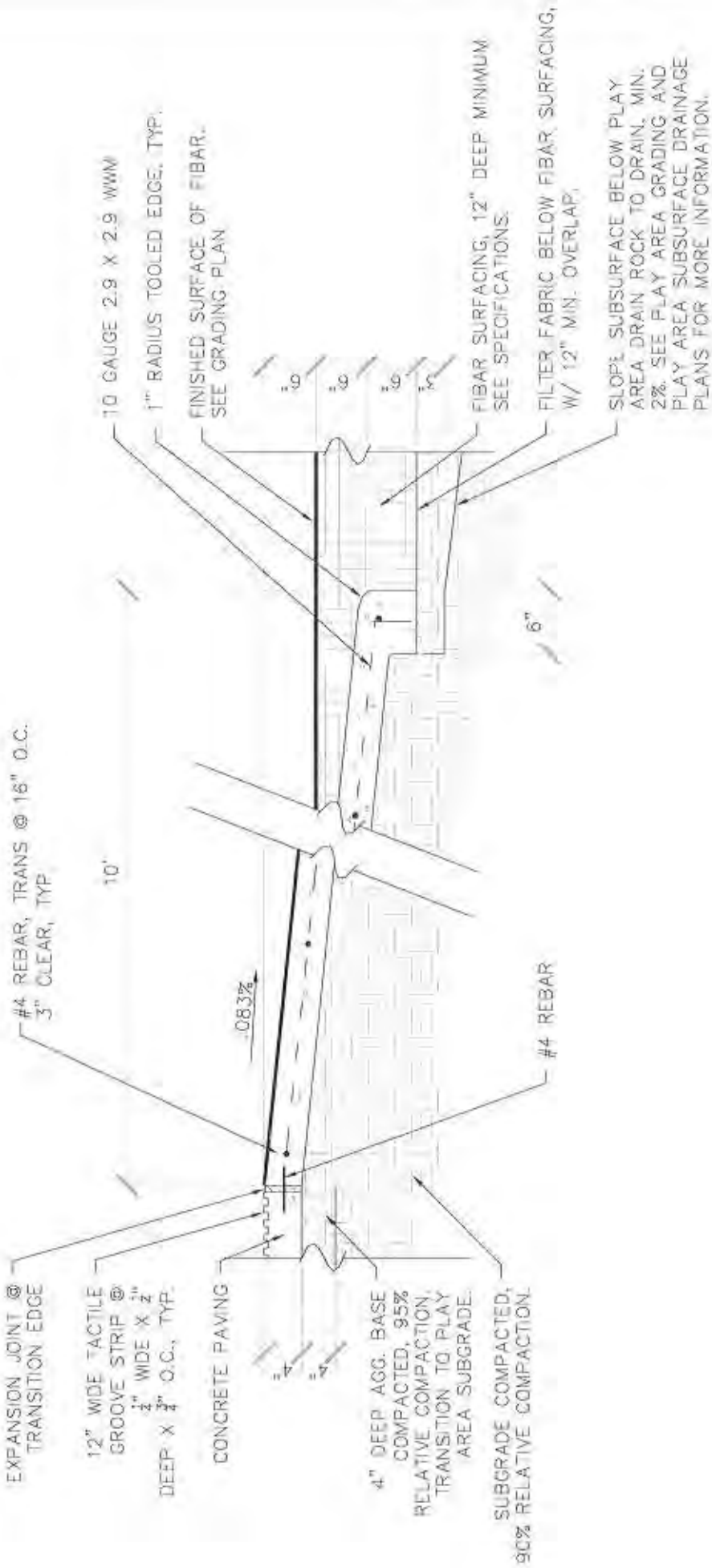

PLAY AREA RAMP -- SECTION

CORDOVA RECREATION AND PARK DISTRICT

SCALE: NOT TO SCALE
REVISED: JULY 2014

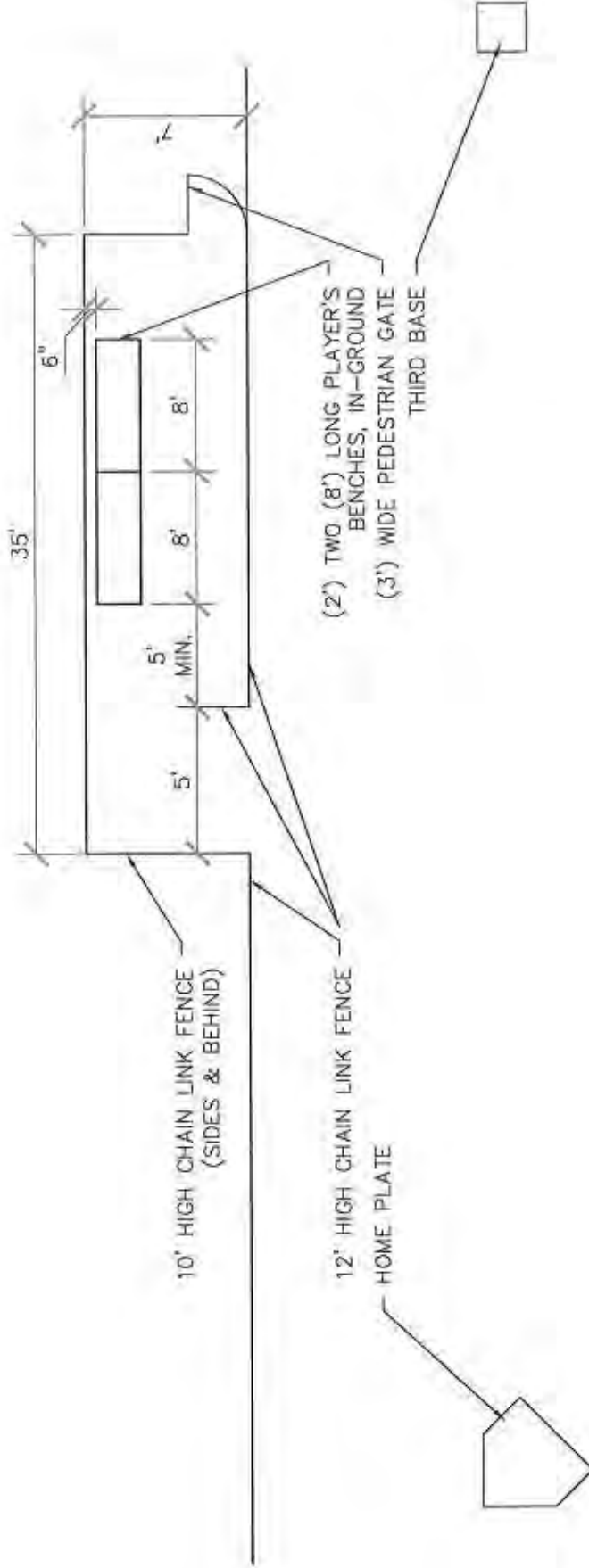

DUGOUT LAYOUT

CORDOVA RECREATION AND PARK DISTRICT

SCALE: NOT TO SCALE
REVISED: JULY 2014

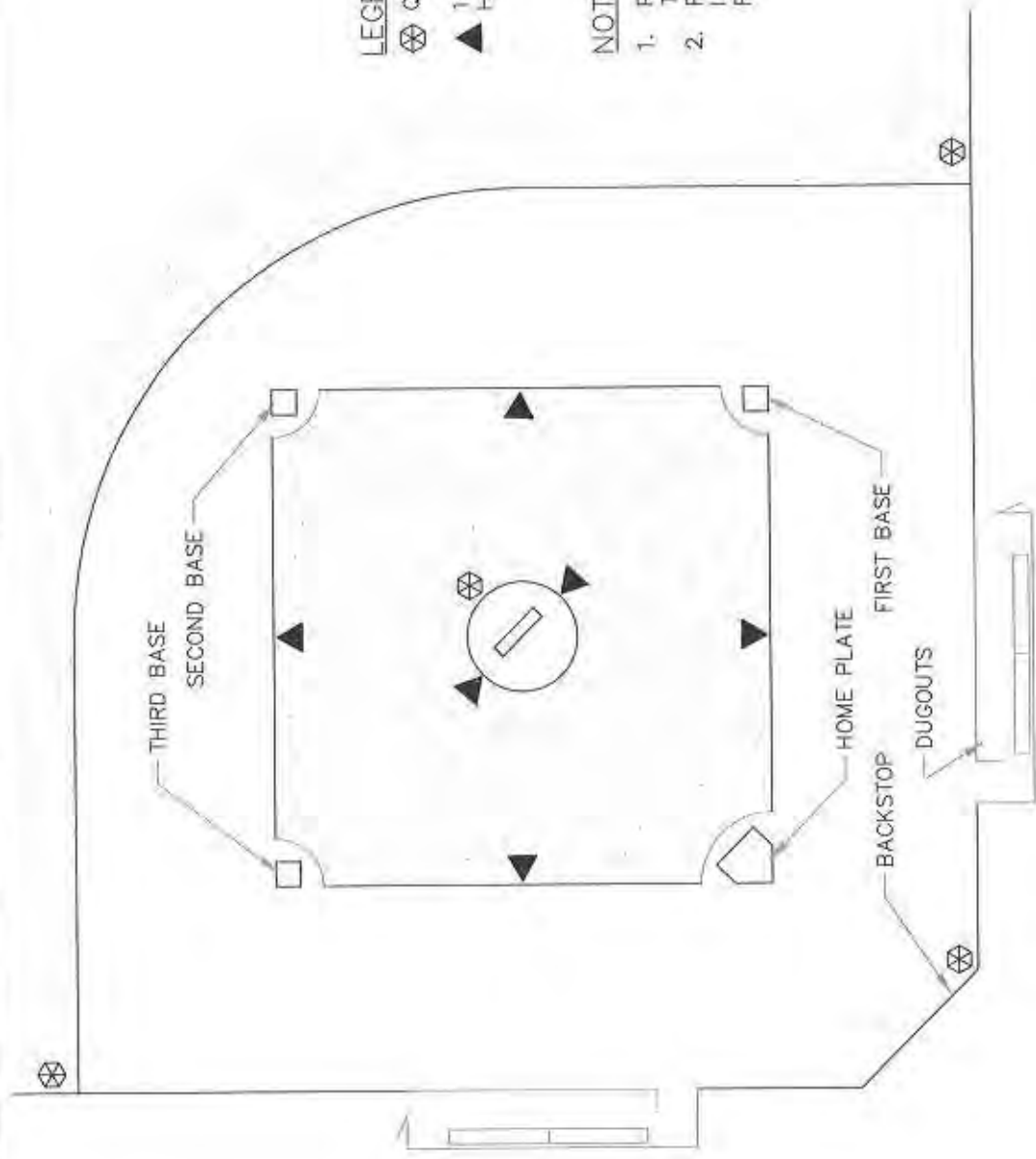

LEGEND

⊗ QUICK COUPLER

▲ 180° ROTOR TURF SPRINKLER HEAD PER SPECIFICATIONS

NOTES

1. PLACE HEADS 4" - 6" INTO THE TURF FROM THE INFIELD EDGE.
2. PROVIDE A BRASS MANUAL IRRIGATION BYPASS VALVE FOR THE QUICK COUPLER SYSTEM.



TURF INFIELD IRRIGATION LAYOUT

CORDOVA RECREATION AND PARK DISTRICT

SCALE: NOT TO SCALE
REVISED: JULY 2014

LEGEND

⊗ QUICK COUPLER

▲ 180° POP-UP TURF SPRINKLER HEAD PER SPECIFICATIONS

● 360° POP-UP TURF SPRINKLER HEAD PER SPECIFICATIONS

○ 12" ROUND VALVE BOX & COVER

⊙ 2" MAXIMUM BRASS BALL VALVE, AT GRADE

NOTES

1. PROVIDE A BRASS MANUAL IRRIGATION BYPASS VALVE FOR THE SPRINKLER HEADS AND QUICK COUPLER SYSTEM.
2. BACKFILL BOXES CONTAINING SPRINKLER HEADS WITH PEA GRAVEL TO A LEVEL 3" FROM BOTTOM OF LID.

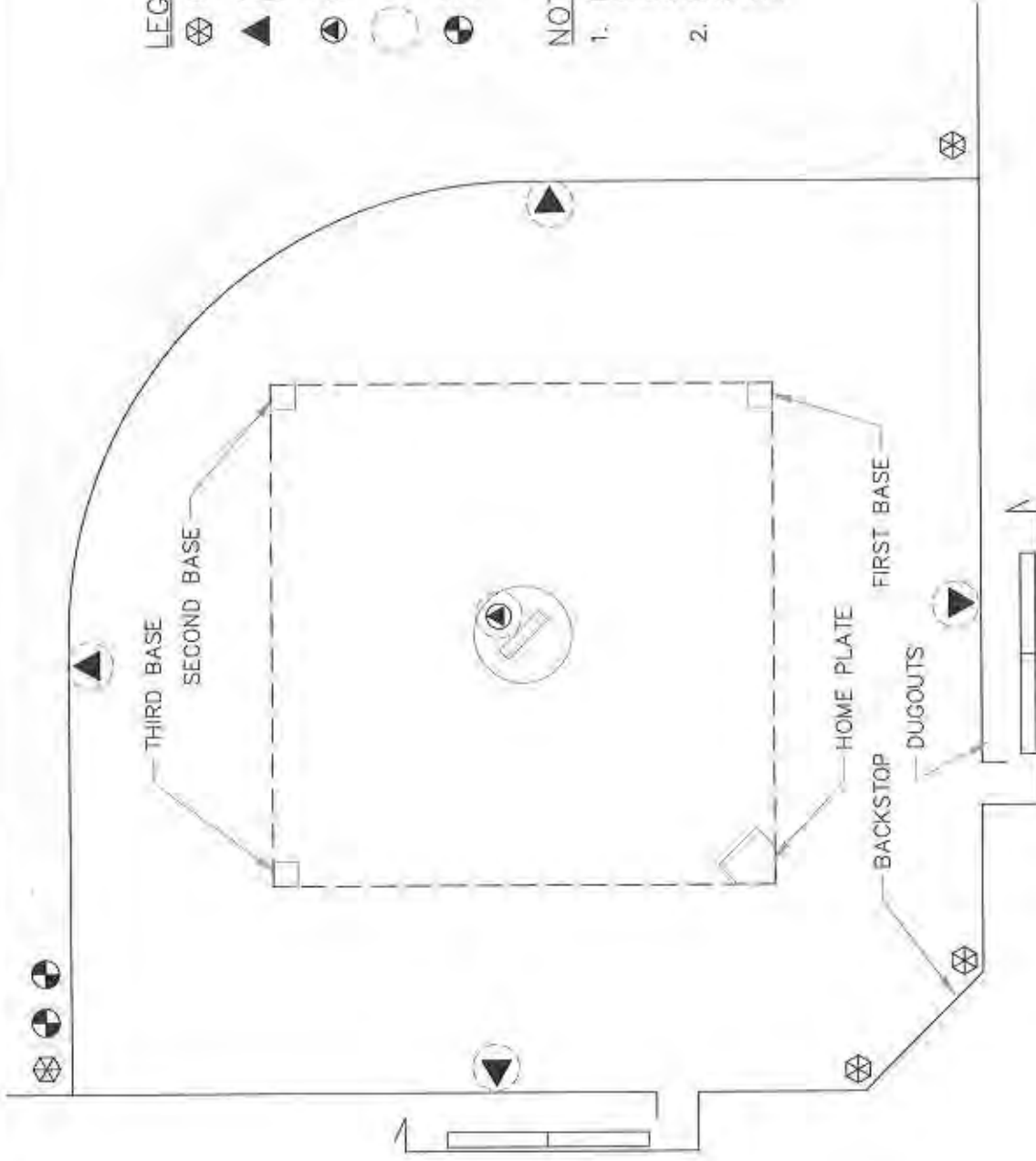

PLAN

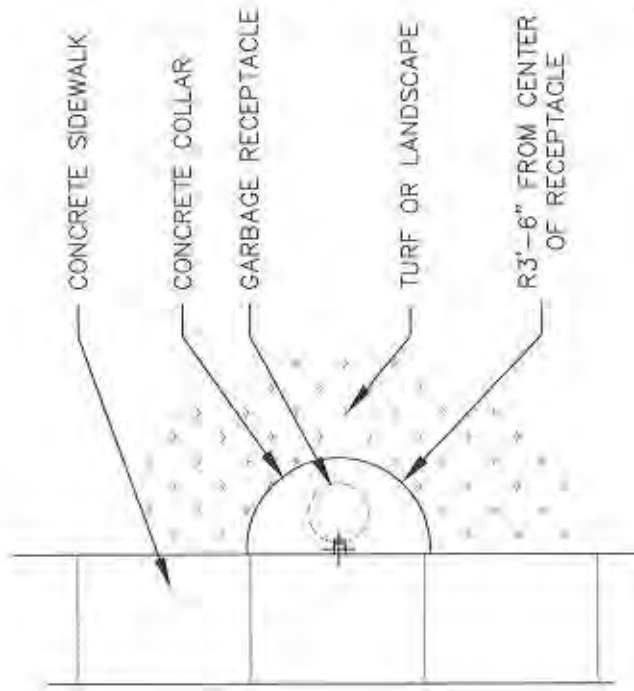

SECTION

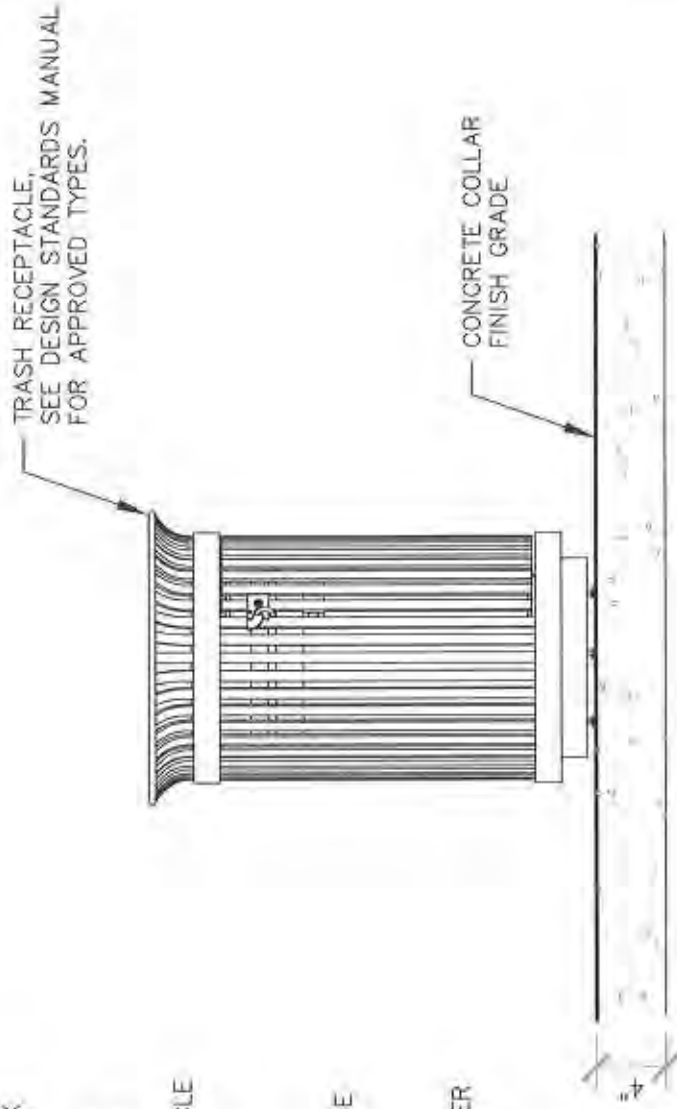

NOTES

1. GRIND ALL WELDS SMOOTH.



TRASH RECEPTACLE

CORDOVA RECREATION AND PARK DISTRICT

SCALE: NOT TO SCALE
REVISED: JULY 2014

BARBEQUE, SEE DESIGN STANDARDS MANUAL FOR APPROVED TYPES

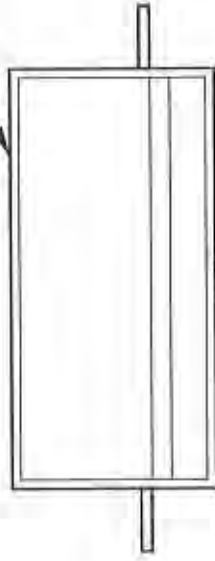

SURFACE MOUNT BBQ

FINISH GRADE OF CONCRETE SLAB

COMPACTED SUBGRADE

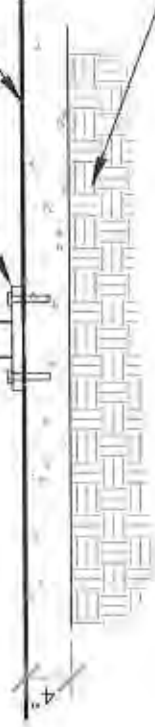

NOTES

1. INSTALL FOOTING PER MANUFACTURER'S SPECIFICATIONS AND DETAILS.



BARBEQUE SURFACE MOUNTED

CORDOVA RECREATION AND PARK DISTRICT

SCALE: NOT TO SCALE
REVISED: JULY 2014

BARBEQUE, TYPE TO BE APPROVED BY CRPD

HEAVY-DUTY, SEVEN GAUGE
STEEL ADJUSTABLE FIREBOX

3-1/2" O.D. STEEL PIPE PEDESTAL,
POWDER COATED BLACK

FINISH GRADE OF CONCRETE SLAB WITH PAVERS

CONCRETE FOOTING, HOLD TOP OF
FOOTING BELOW FINISHED PAVING

COMPACTED SUBGRADE

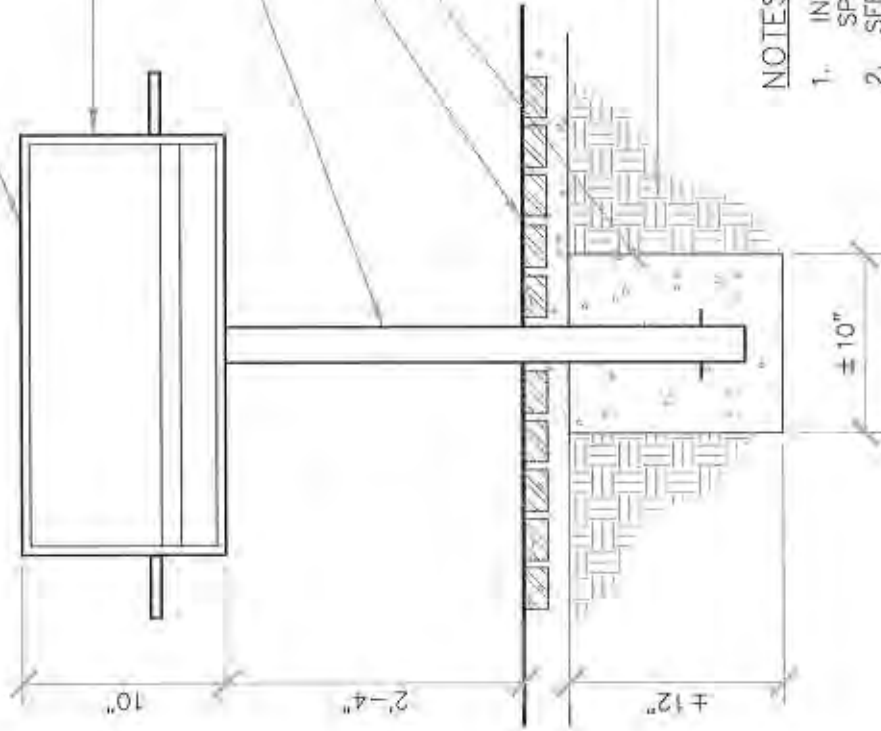

NOTES

1. INSTALL FOOTING PER MANUFACTURER'S SPECIFICATIONS AND DETAILS.
2. SEE DESIGN STANDARDS MANUAL FOR APPROVED BBQ TYPES..

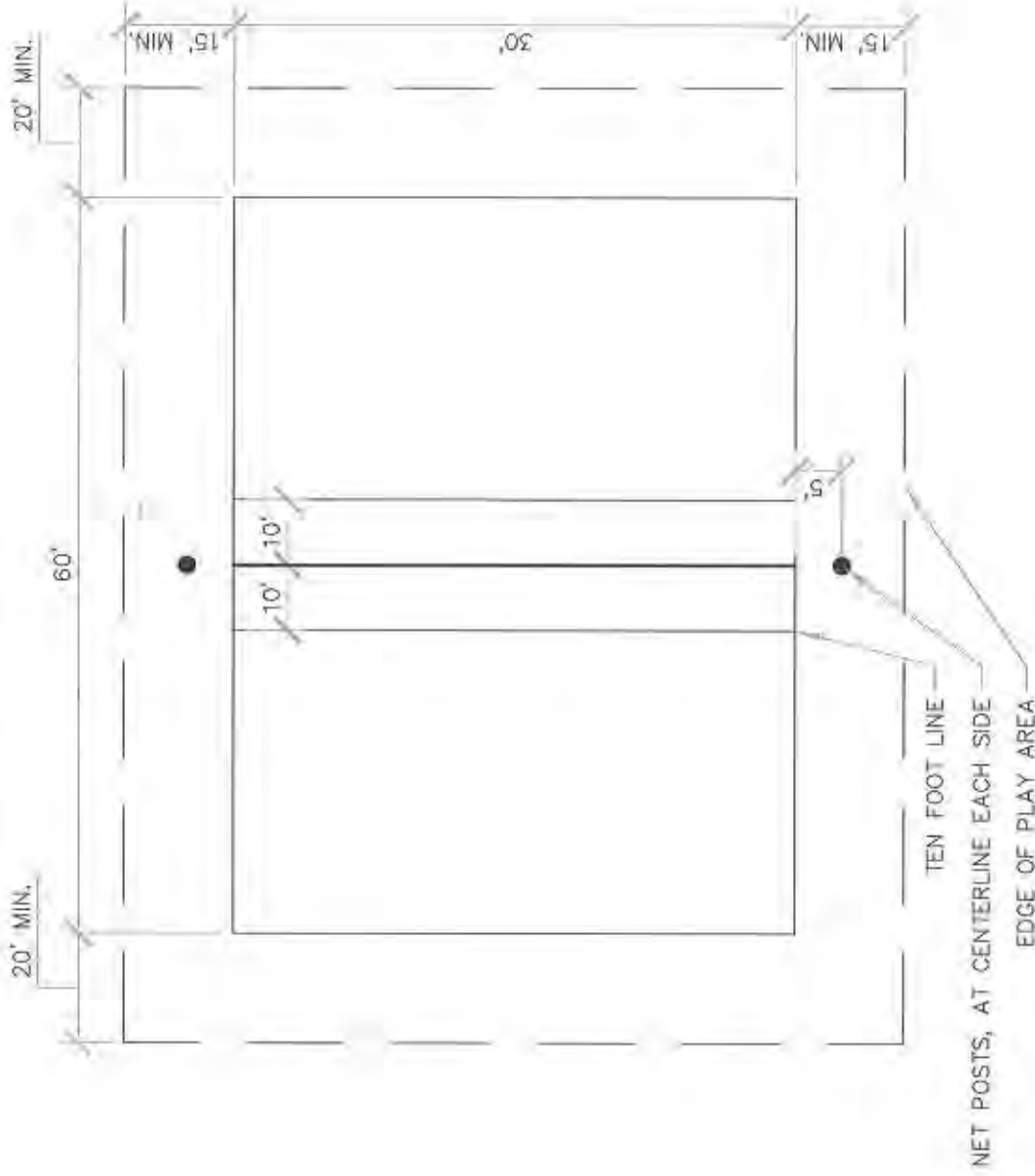

VOLLEYBALL COURT LAYOUT
CORDOVA RECREATION AND PARK DISTRICT

SCALE: NOT TO SCALE
REVISED: JULY 2014

40'

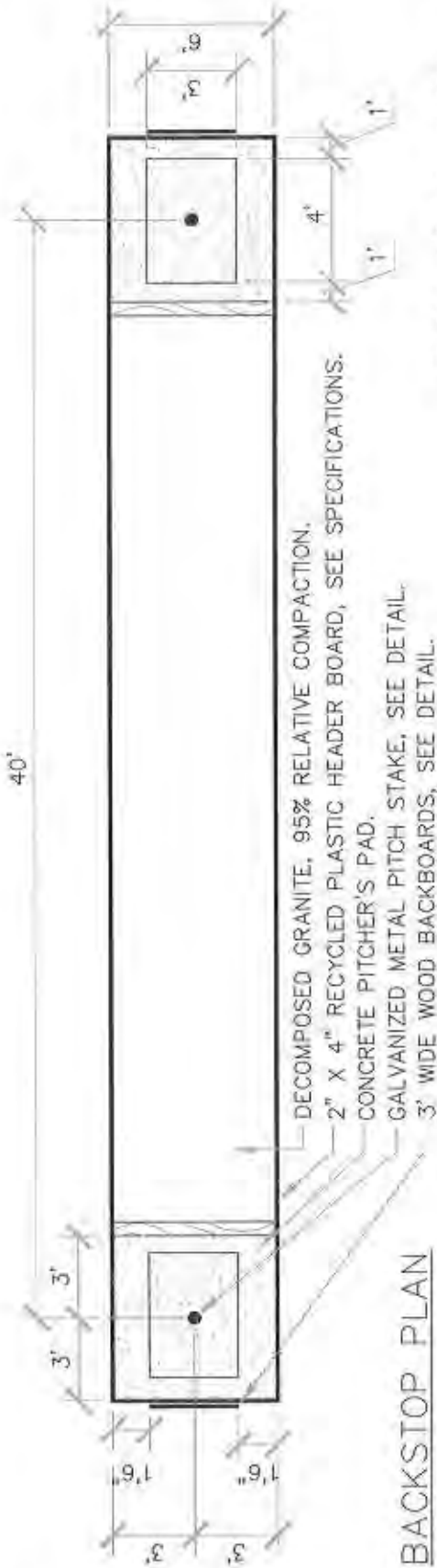

BACKSTOP PLAN

- DECOMPOSED GRANITE, 95% RELATIVE COMPACTION.
- 2" X 4" RECYCLED PLASTIC HEADER BOARD, SEE SPECIFICATIONS.
- CONCRETE PITCHER'S PAD.
- GALVANIZED METAL PITCH STAKE, SEE DETAIL.
- 3' WIDE WOOD BACKBOARDS, SEE DETAIL.

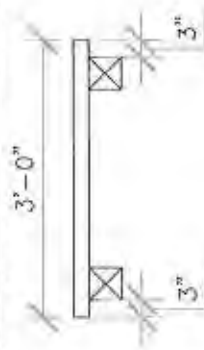

HORSESHOE PIT SECTION

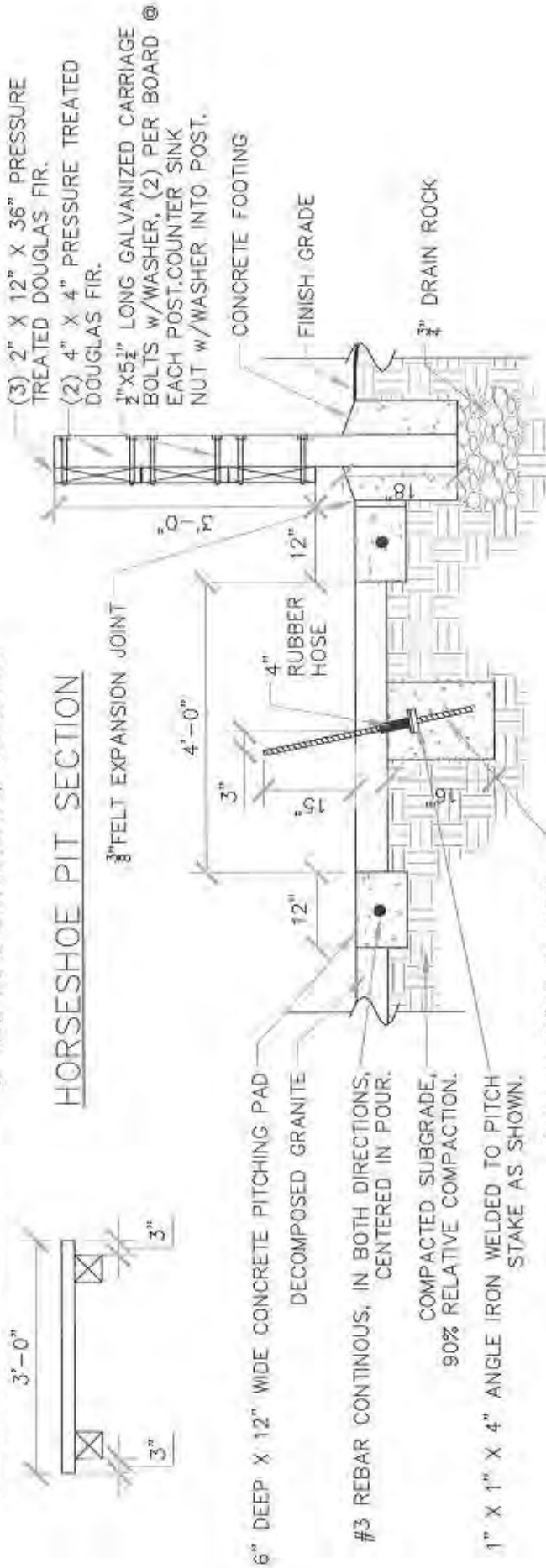

- 6" DEEP X 12" WIDE CONCRETE PITCHING PAD
- DECOMPOSED GRANITE
- #3 REBAR CONTINUOUS, IN BOTH DIRECTIONS, CENTERED IN POUR.
- COMPACTED SUBGRADE, 90% RELATIVE COMPACTION.
- 1" X 1" X 4" ANGLE IRON WELDED TO PITCH STAKE AS SHOWN.
- 1" DIA. X 36" GALVANIZED METAL PITCH STAKE
- 3/8" FELT EXPANSION JOINT
- 4'-0"
- 4" RUBBER HOSE
- 3"
- 12"
- 12"
- CONCRETE FOOTING
- FINISH GRADE
- 3/4" DRAIN ROCK

- (3) 2" X 12" X 36" PRESSURE TREATED DOUGLAS FIR.
- (2) 4" X 4" PRESSURE TREATED DOUGLAS FIR.
- 2" X 5 1/2" LONG GALVANIZED CARRIAGE BOLTS w/WASHER, (2) PER BOARD @ EACH POST.COUNTER SINK NUT w/WASHER INTO POST.



HORSESHOE COURT LAYOUT
CORDOVA RECREATION AND PARK DISTRICT

SCALE: NOT TO SCALE
 REVISED: JULY 2014

SECTION

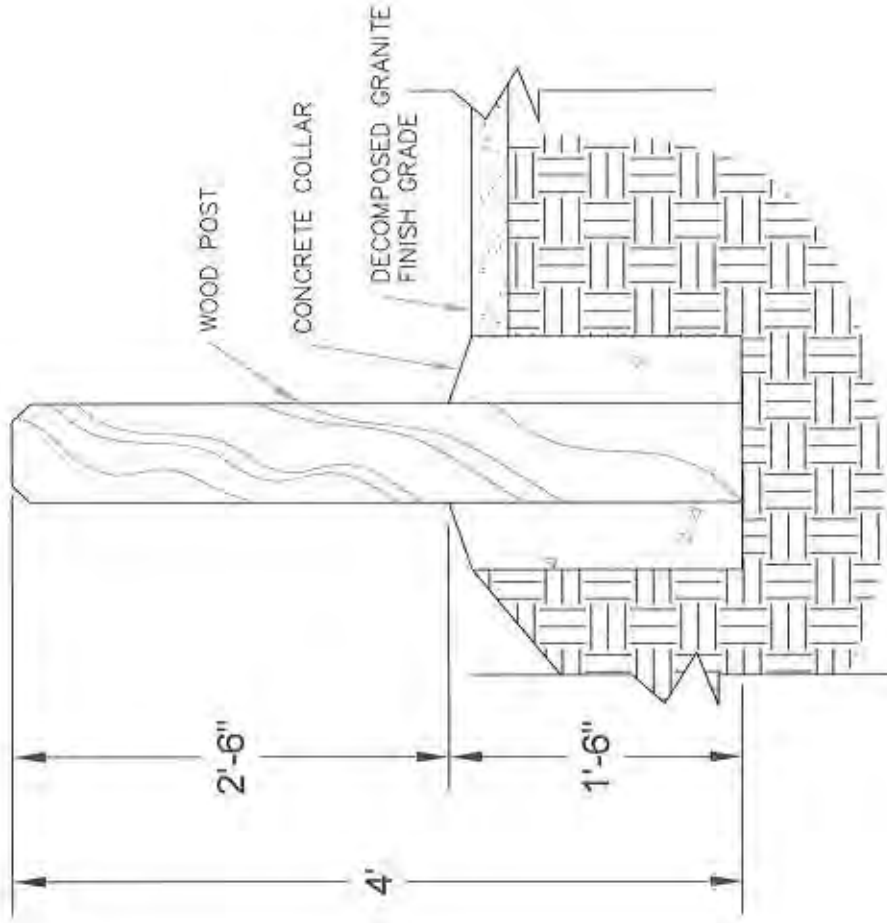

WOOD BOLLARD WITH CONCRETE COLLAR

CORDOVA RECREATION AND PARK DISTRICT

SCALE: NOT TO SCALE
REVISED: JULY 2014

BRACE TO BE REMOVED AFTER ALL OTHER FENCE CONSTRUCTION IS COMPLETED UNLESS OTHERWISE DIRECTED BY THE ENGINEER.

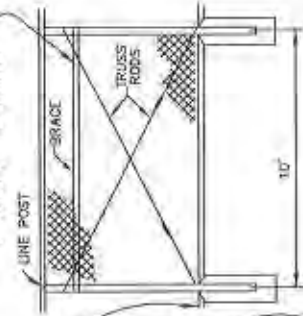

LINE POSTS AT 10' (1000 MAX.) INTERVALS BRACED AND TRUSSED IN BOTH DIRECTIONS EXCEPT THAT THIS BRACING AND TRUSSING MAY BE OMITTED WHEN THE FABRIC IS STRETCHED BY EQUIPMENT.

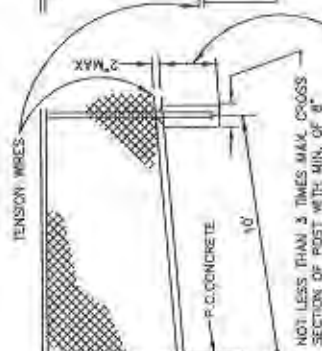

NOT LESS THAN 3 TIMES MAX. CROSS SECTION OF POST WITH MIN. OF 8"

2'-6" FOR FABRIC LESS THAN 60" HIGH
3'-0" FOR FABRIC 60" AND OVER

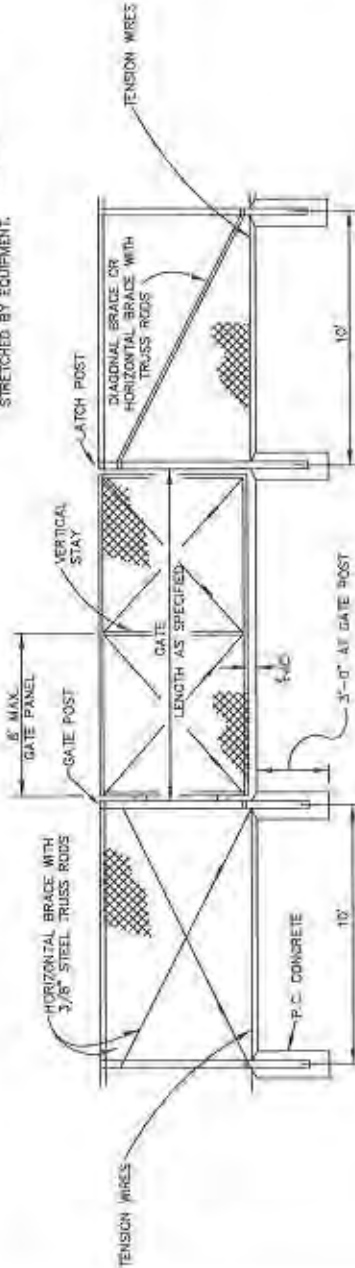

TYPE CL-4-448* FABRIC (9 GAUGE)
TYPE CL-5-72* FABRIC (9 GAUGE)

END AND CORNER POST ASSEMBLY
3'-6" FOR FABRIC LESS THAN 60" HIGH
3'-0" FOR FABRIC 60" AND OVER

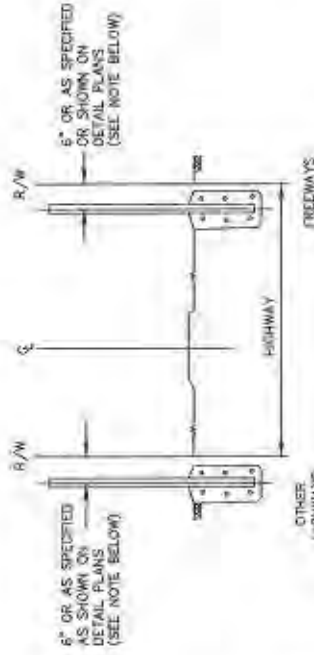

NOTES

1. OFFSET TO BE 2'-0" AT MONUMENT LOCATIONS, MEASURED AT RIGHT ANGLES TO R/W LINES. TAPER TO ACHIEVE OFFSET TO BE AT LEAST 20' LONG.

FENCE LOCATION

FENCE HEIGHT	GATE WIDTHS		NOMINAL I.D.	WEIGHT PER FOOT
	UP THRU 6'	OVER 6' THRU 12'		
6'-0" AND LESS	UP THRU 6'	OVER 6' THRU 12'	2-1/2"	4.85
	OVER 12' THRU 16'	OVER 18' TO 24' MAX.	5"	10.78
	UP THRU 6'	OVER 6' THRU 12'	6"	14.52
OVER 6'	UP THRU 6'	OVER 12' THRU 18'	3"	7.58
	OVER 6' THRU 12'	OVER 18' TO 24' MAX.	5"	14.52
	UP THRU 6'	OVER 12' THRU 18'	6"	18.97

NOTES

1. ABOVE POST DIMENSIONS AND WEIGHTS ARE MINIMUMS. LARGER SIZES MAY BE USED ON APPROVAL OF ENGINEER.

TYPICAL MEMBER DIMENSIONS

FENCE HEIGHT	LINE POSTS		END, LATCH & CORNER POSTS		BRACES	
	ROUND (I.D.)	ROLL FORMED	ROUND (I.D.)	ROLL FORMED	H	ROLL FORMED
6" AND LESS	1-1/2"	1-1/8" X 1-5/8"-3/4"	2"	3-1/2" X 3-1/2" X 1-3/4"	1-1/4" X 1-1/2" X 1-1/4"	1-1/4" X 1-1/2" X 1-1/4"
OVER 6"	2"	2-1/4" X 2"	2-1/2"	3-1/2" X 3-1/2" X 1-3/4"	1-1/4" X 1-1/2" X 1-1/4"	1-1/4" X 1-1/2" X 1-1/4"

NOTES

1. THE ABOVE TABLE SHOWS EXAMPLES OF POST AND BRACE SECTIONS WHICH MAY COMPLY WITH THE SPECIFICATIONS.
2. SECTIONS WHICH DO NOT COMPLY WITH THE SPECIFICATIONS SHOULD BE SUBMITTED TO THE ENGINEER FOR APPROVAL.
3. APPROVAL OF THE ENGINEER SHALL BE OBTAINED BEFORE CONSTRUCTION OF THE PROJECT.
4. DIMENSIONS SHOWN ARE NOMINAL.



CHAINLINK FENCE

CORDOVA RECREATION AND PARK DISTRICT

SCALE: NOT TO SCALE
REVISED: JULY 2014

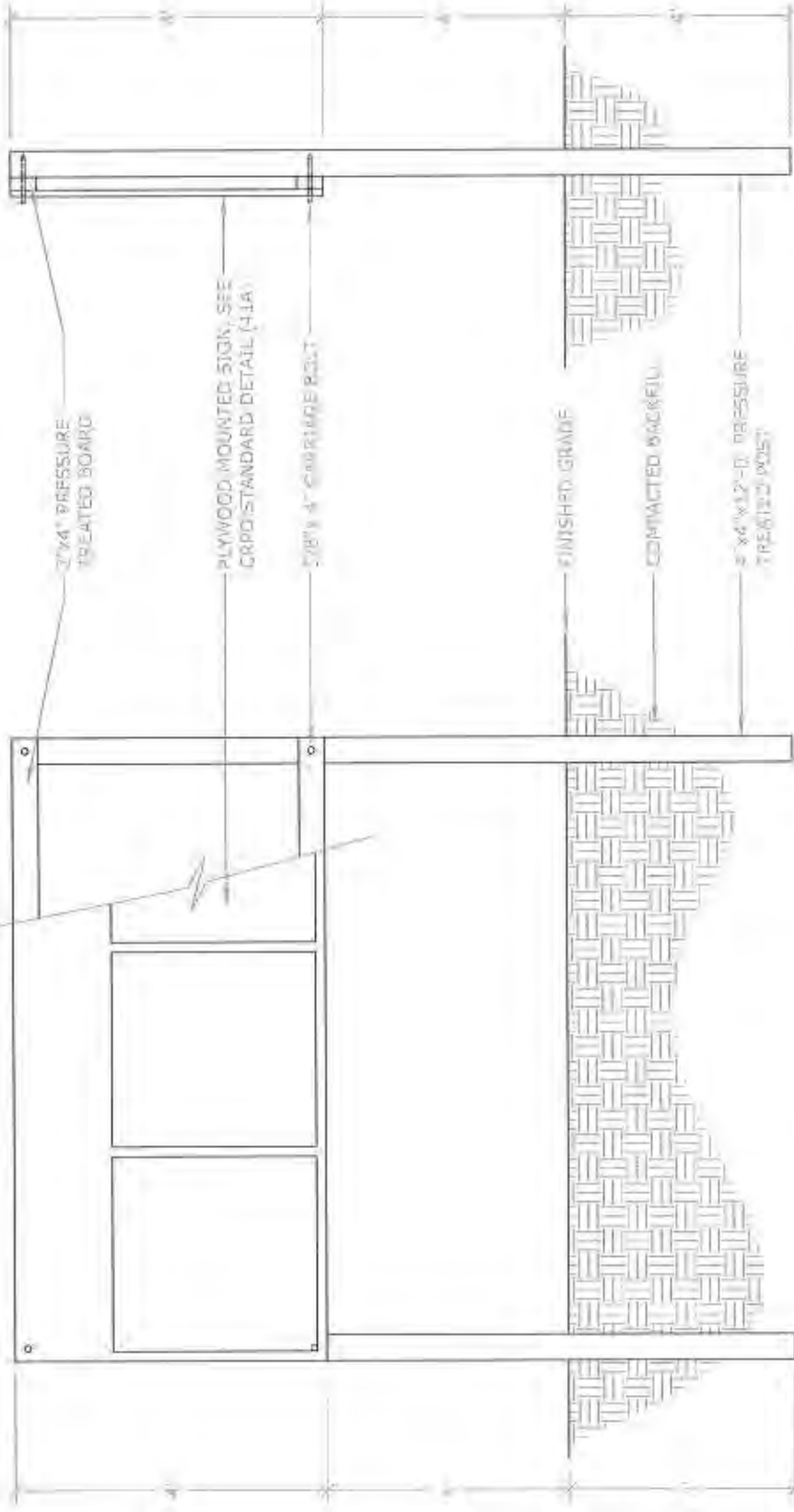

FRONT VIEW

SIDE VIEW

NOTE:

1. SEE CRPD CONSTRUCTION STANDARD DETAIL (41A) FOR ADDITIONAL INFORMATION.



PARK CONSTRUCTION PROJECT SIGN

CORDOVA RECREATION AND PARK DISTRICT

SCALE: NOT TO SCALE
REVISED: JULY 2014

AREA LIGHT WITH CONCRETE COLLAR

CORDOVA RECREATION AND PARK DISTRICT

SCALE: NOT TO SCALE
REVISED: JULY 2014

SECTION

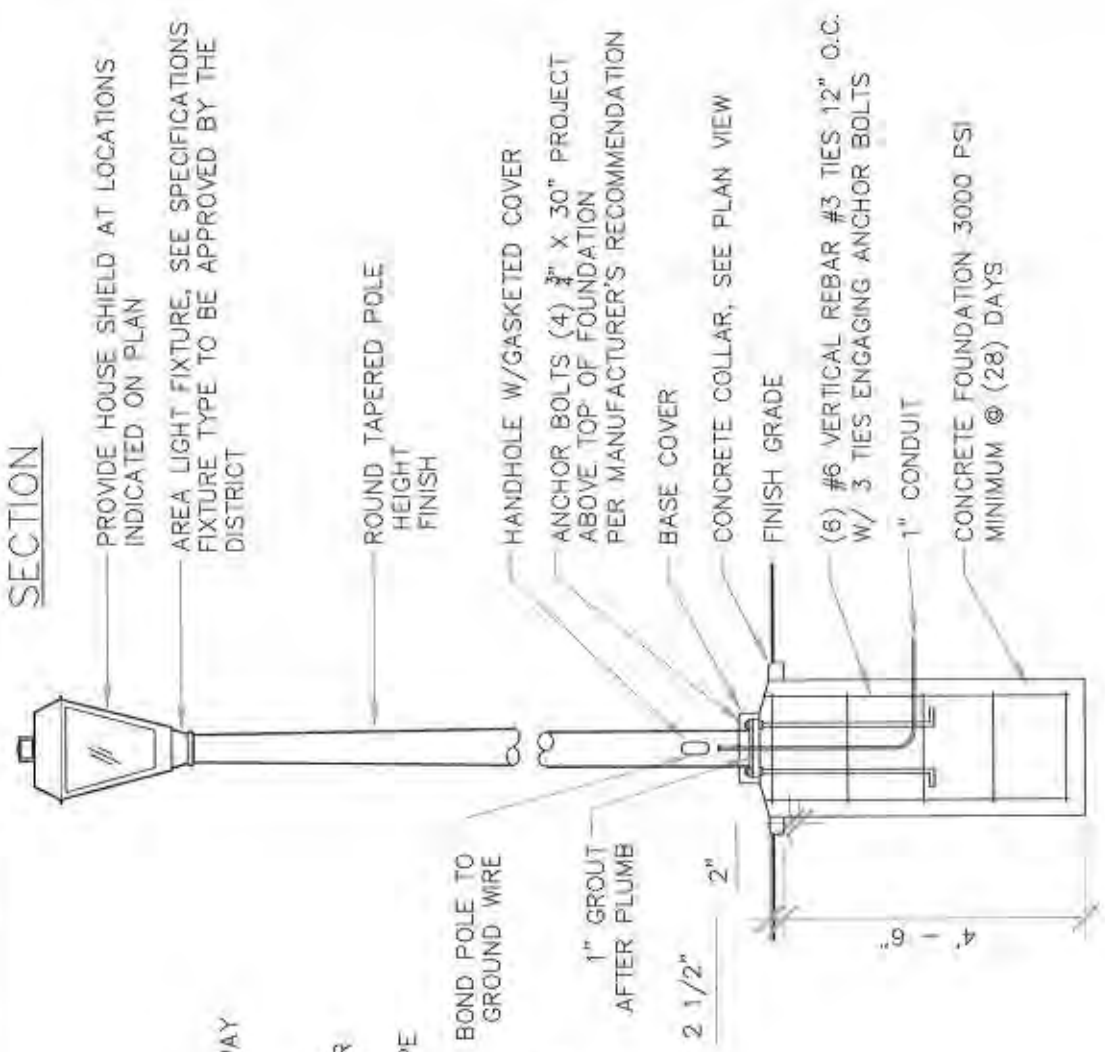

PLAN

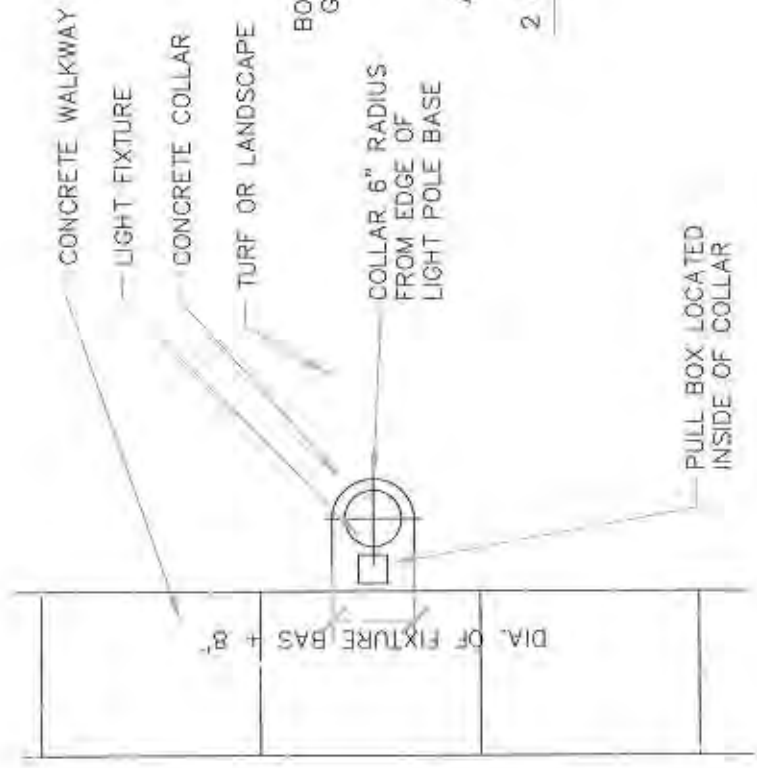

NOTES

1. INCLUDE MANUAL BYPASS IN POWER PEDESTAL FOR MANUAL OVERRIDE.
2. ALL LIGHTS TO BE LOCATED ADJACENT TO WALKWAYS.

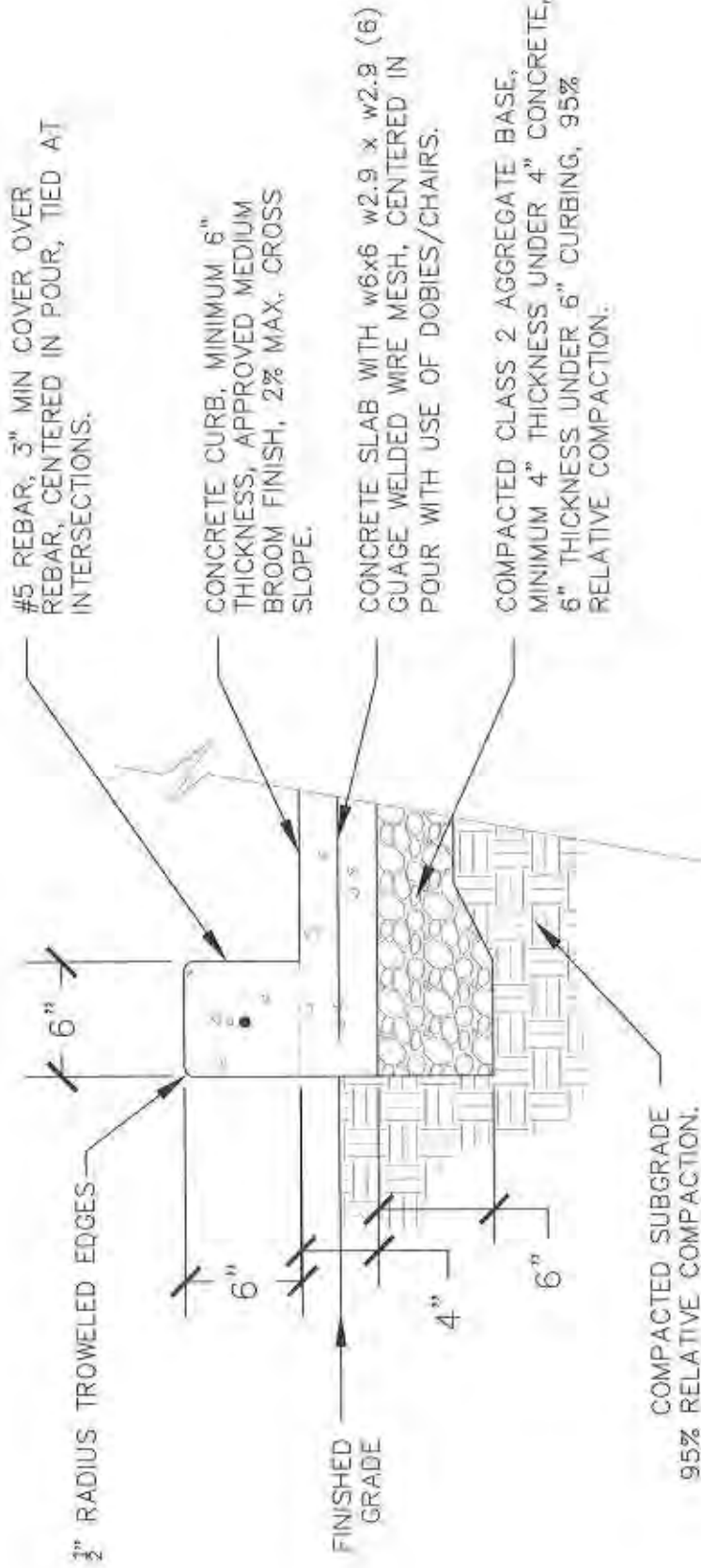

CONCRETE CURBING / EDGING

CORDOVA RECREATION AND PARK DISTRICT

SCALE: NOT TO SCALE
 REVISED: JULY 2014

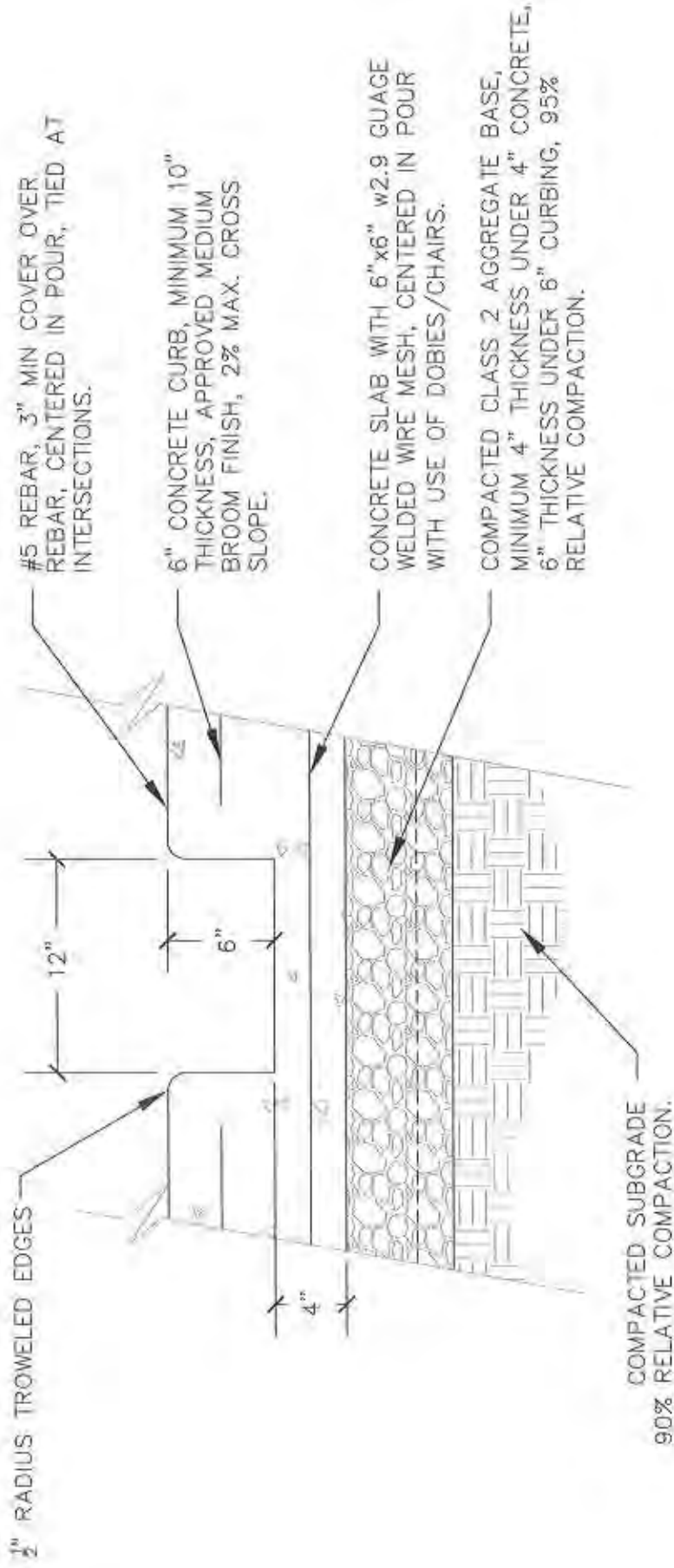

1/2" RADIUS TROWELED EDGES

#5 REBAR, 3" MIN COVER OVER REBAR, CENTERED IN POUR, TIED AT INTERSECTIONS.

6" CONCRETE CURB, MINIMUM 10" THICKNESS, APPROVED MEDIUM BROOM FINISH, 2% MAX. CROSS SLOPE.

CONCRETE SLAB WITH 6"x6" w2.9 GAUGE WELDED WIRE MESH, CENTERED IN POUR WITH USE OF DOBIES/CHAIRS.

COMPACTED CLASS 2 AGGREGATE BASE, MINIMUM 4" THICKNESS UNDER 4" CONCRETE, 6" THICKNESS UNDER 6" CURBING, 95% RELATIVE COMPACTION.

COMPACTED SUBGRADE 90% RELATIVE COMPACTION.

CONCRETE CURBING / EDGING CUTOUT

CORDOVA RECREATION AND PARK DISTRICT

SCALE: NOT TO SCALE
REVISED: JULY 2014

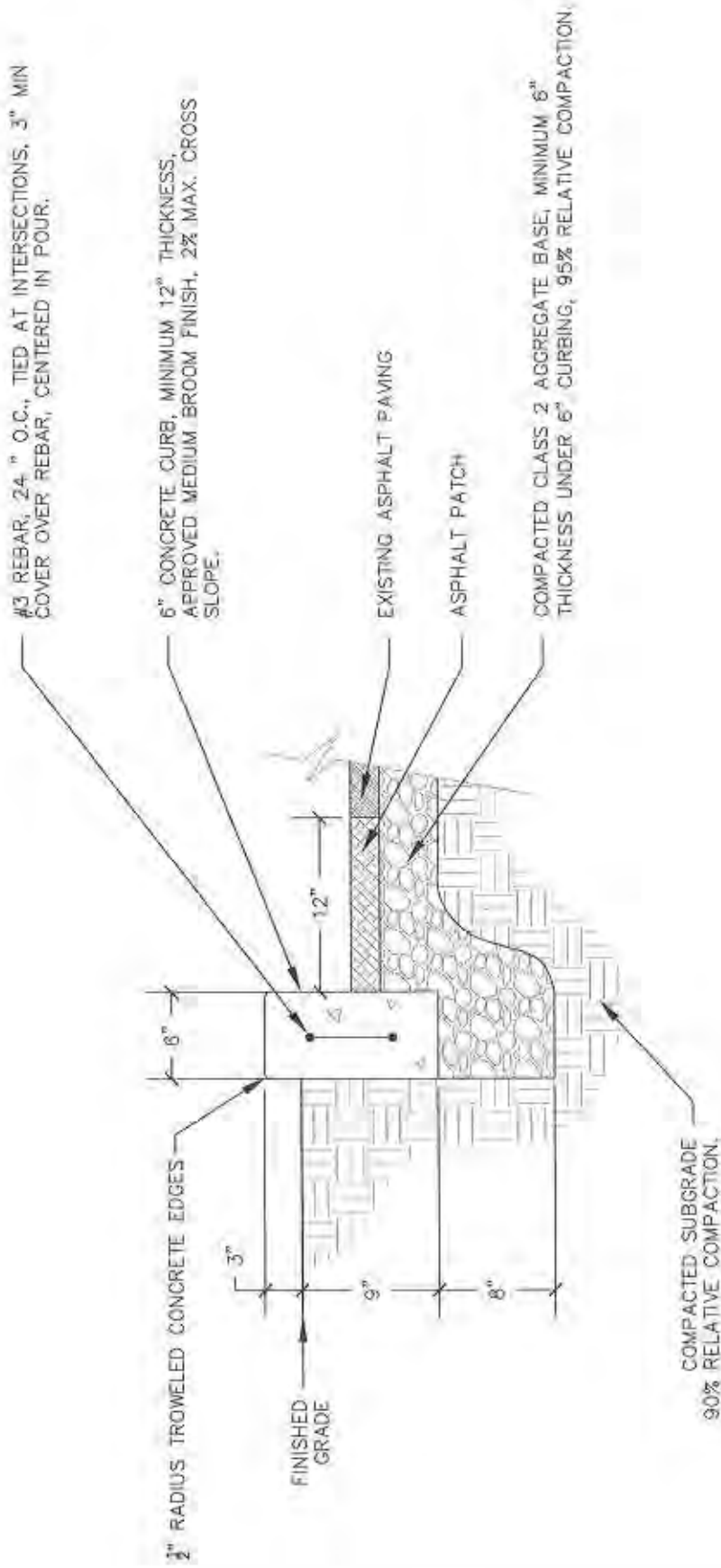

CONCRETE CURBING ALONG ASPHALT

CORDOVA RECREATION AND PARK DISTRICT

SCALE: NOT TO SCALE
 REVISED: JULY 2014

1/2" RADIUS TROWELED EDGES

APPLY SELF-LEVELING SIKAFLEX ON TOP OF FELT EXPANSION JOINT, w/DOWELS @ 8' O.C., AT ALL VERTICAL SURFACES.

CONCRETE SIDEWALK SLAB, MINIMUM 4" THICKNESS, WITH APPROVED MEDIUM BROOM FINISH w/TEST PANEL, 2% MAX. CROSS SLOPE.

W6X6 W2.9 x W2.9 (6) GAUGE WELDED WIRE MESH, CENTERED IN POUR WITH USE OF DOBIES/CHAIRS.

COMPACTED CLASS 2 AGGREGATE BASE, MINIMUM 4" THICKNESS UNDER 4" CONCRETE, 6" THICKNESS UNDER 6" CURBING, 95% RELATIVE COMPACTION.

#4 REBAR x 30" @ 12" O.C., TIED AT INTERSECTIONS, 2" MIN. COVER OVER REBAR CENTERED IN POUR.

COMPACTED SUBGRADE 90% RELATIVE COMPACTION.

CUT ASPHALT

ASPHALT PATCH

EXISTING ASPHALT

FINISHED GRADE

EXISTING AGGREGATE BASE

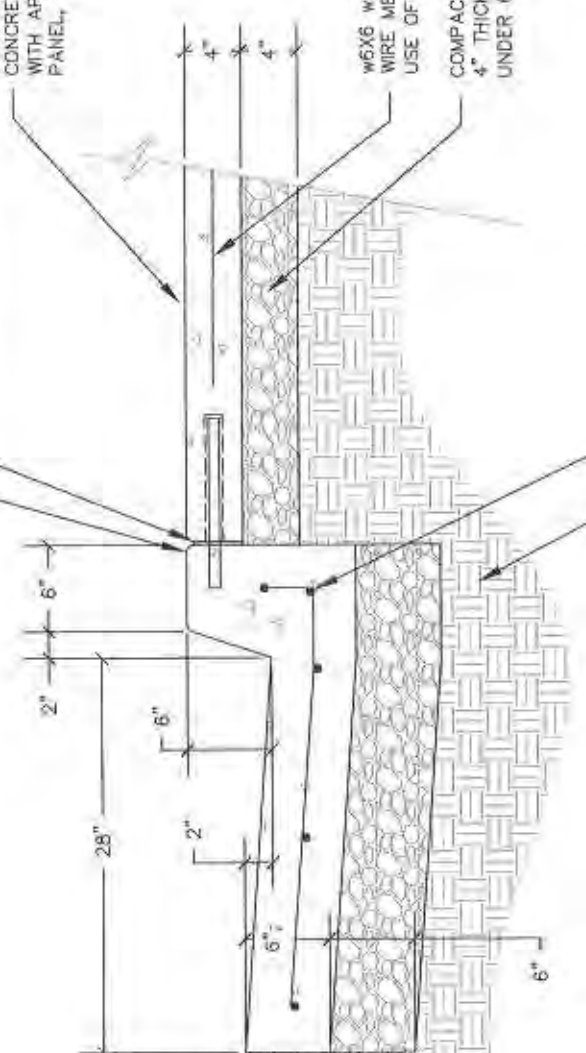

CONCRETE CURB AND GUTTER

CORDOVA RECREATION AND PARK DISTRICT

SCALE: NOT TO SCALE
REVISED: JULY 2014

NOTE: APPLY SELF-LEVELING SIKAFLEX ON TOP OF FELT EXPANSION JOINTS AND SNAP CAPS

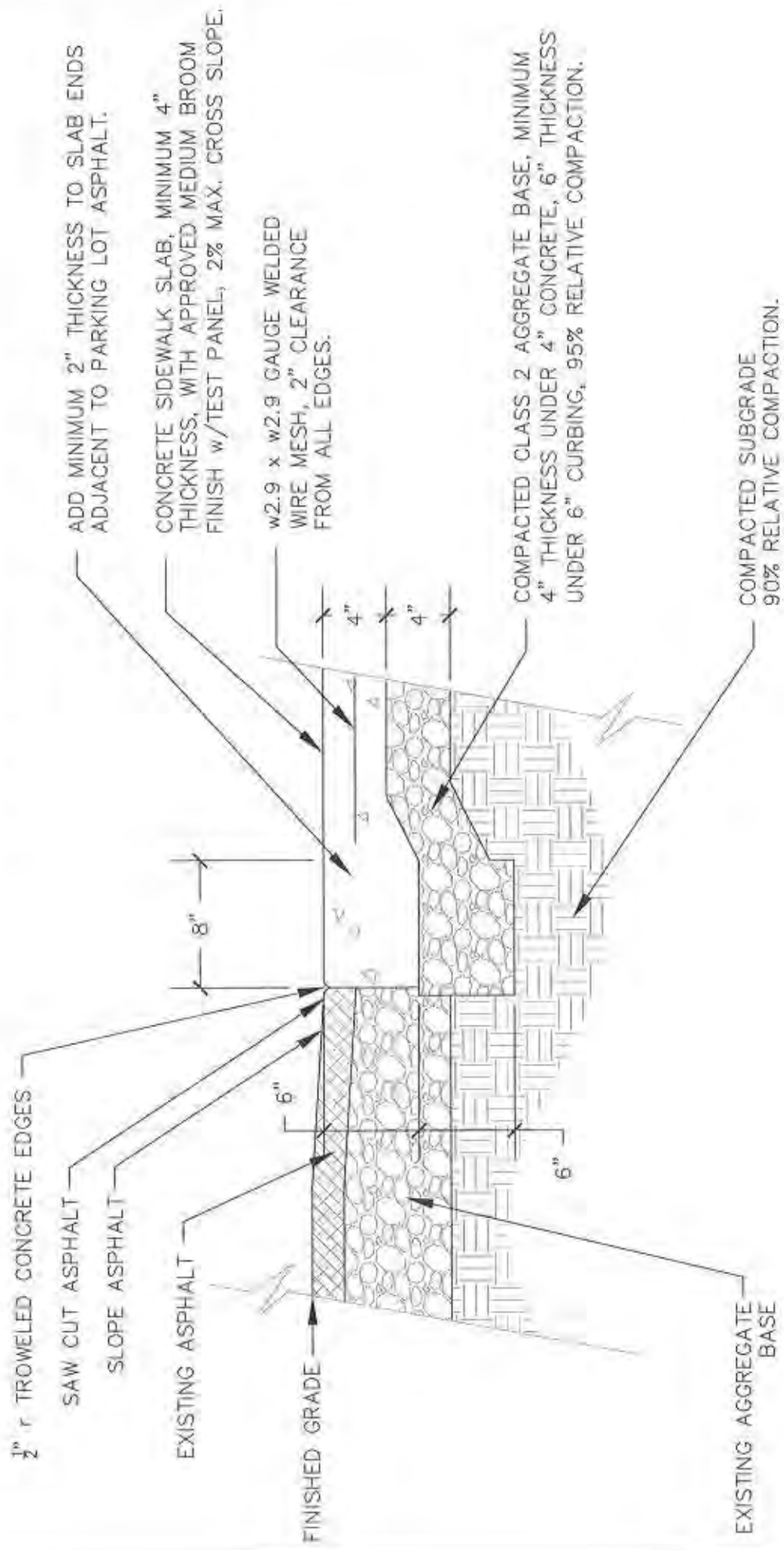

CONCRETE WALK AT ASPHALT

CORDOVA RECREATION AND PARK DISTRICT

SCALE: NOT TO SCALE
REVISED: JULY 2014

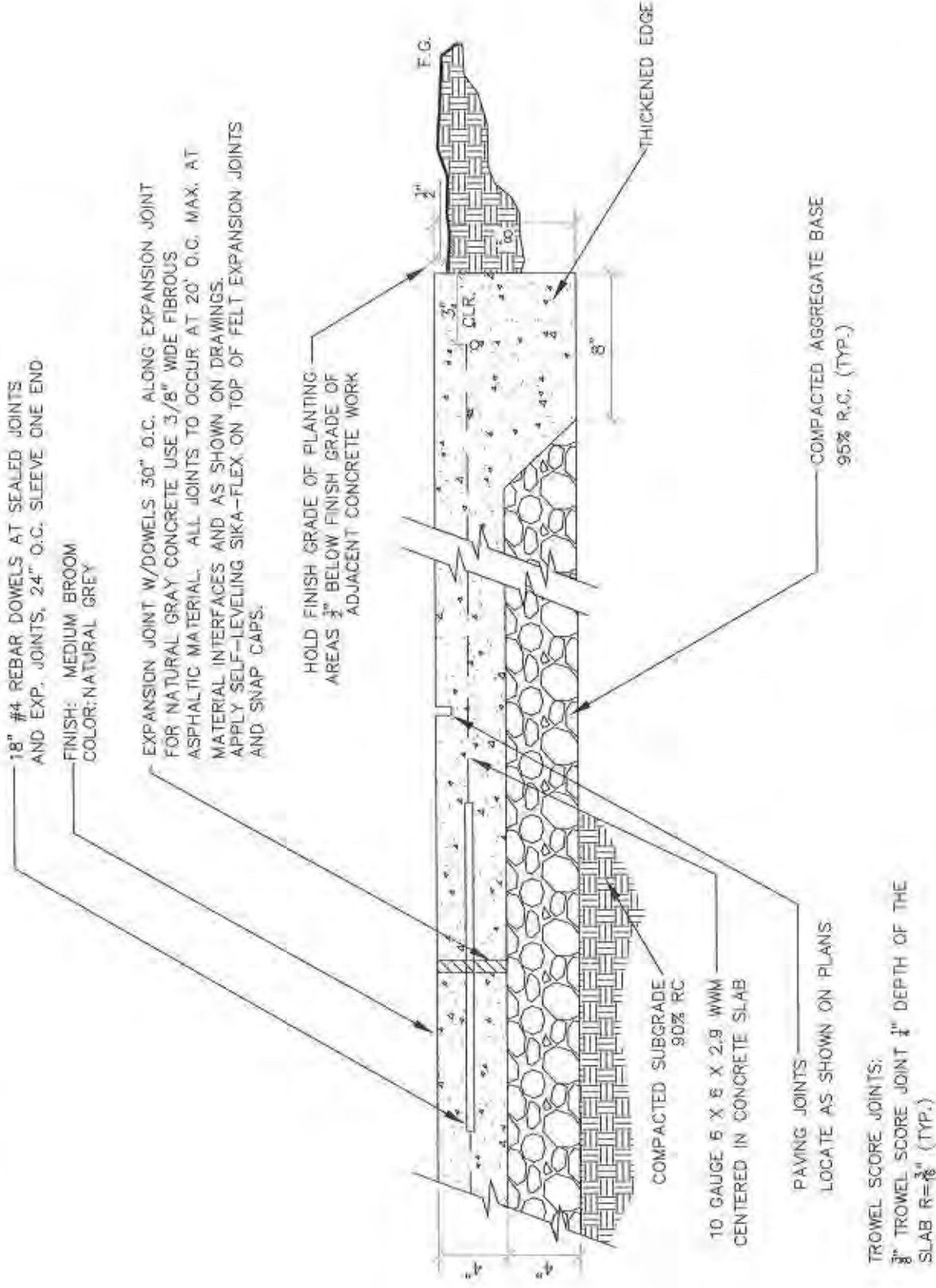

CONCRETE PAVING

CORDOVA RECREATION AND PARK DISTRICT

8" MIN.
24" MIN. O.C.

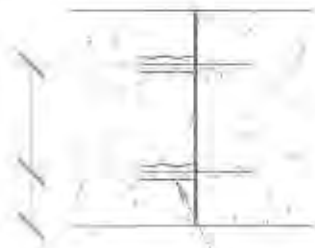

12" LONG #4 SMOOTH
DOWELS AT 24" O.C.
LOCATE HORIZONTALLY
IN CENTER OF SLAB,
PAPER-WRAP ONE END

PLAN VIEW

1/8" RADIUS
EDGE



SECTION

DOWELED COLD JOINT

1/8"

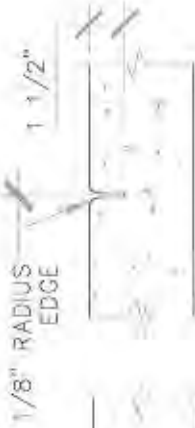

SECTION

SCORE JOINT
(WEAKENED PLANE)

MONOLITHIC POUR



T AND Y INTERSECTION

MONOLITHIC POUR

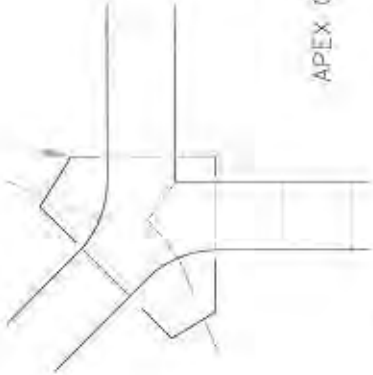

Y INTERSECTION

MONOLITHIC POUR

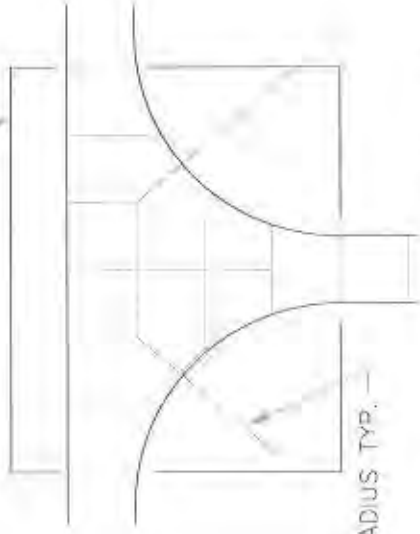

APEX OF RADIUS TYP.

LARGE T INTERSECTION

NOTES

1. CONTROL JOINTS SHALL NOT DIVIDE CONCRETE INTO SHAPES CONTAINING AN INTERIOR ANGLE OF 45 DEGREES OR LESS.
2. JOINTS SHALL BE SPACED EQUAL TO THE WIDTH OF THE PATH. EXAMPLE: A (10') WIDE PATH SHALL HAVE JOINTS SPACED AT (10') O.C.